

Team Strike Evo



Storie collegate

M3 Mobili, Mexico City, Messico (2023)

Team Strike Evo Chefsessel, mit weissem Ru?ckenlehnenrahmen

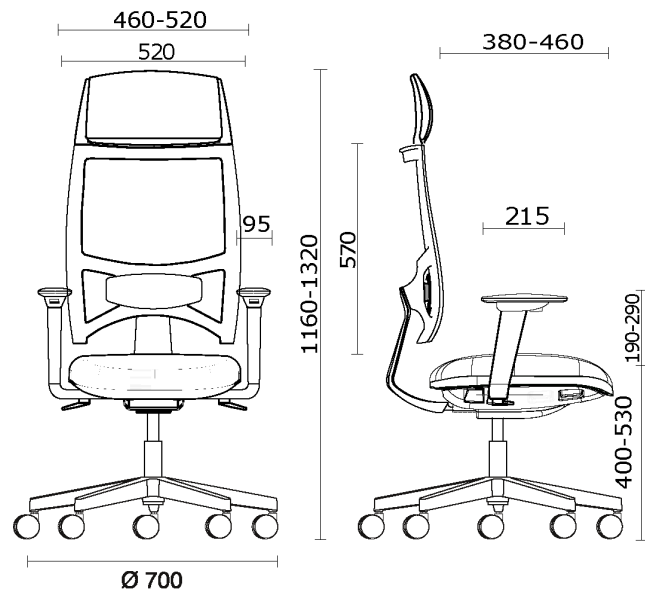

Materiali e rivestimenti

Rückenlehne in Mesh

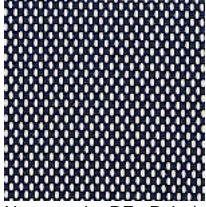

Netzgewebe RF - Polo /
FiDiVi Service
Colori disponibili: 5

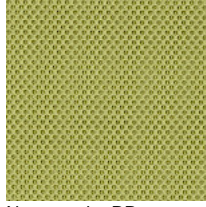

Netzgewebe RR -
Runner / Gabriel
Colori disponibili: 10

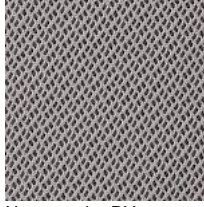

Netzgewebe RY -
Rhythm / Gabriel
Colori disponibili: 6

Sitzbezug mit Rückenlehne in Mesh



Beschichteter Stoff NX
Colori disponibili: 11



Beschichteter Stoff SC -
Secret / Flukso
Colori disponibili: 10

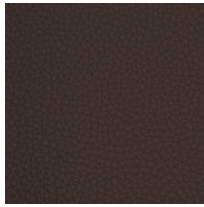

Beschichteter Stoff NX
Colori disponibili: 1

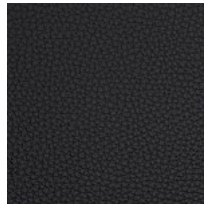

Leder SX - Box Land /
Dani
Colori disponibili: 12



Stoff AL - Alba / FiDiVi
Colori disponibili: 10



Stoff BN - Bondai /
FiDiVi
Colori disponibili: 10

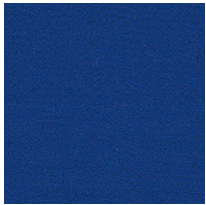

Stoff AB - Xtreme Plus /
Camira
Colori disponibili: 10



Stoff ME - Medley /
Gabriel
Colori disponibili: 15

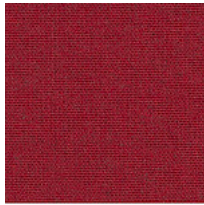

Stoff MF - Main Line
Flax / Camira
Colori disponibili: 10

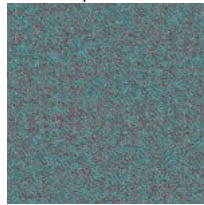

Stoff SY - Sinergy /
Camira
Colori disponibili: 10

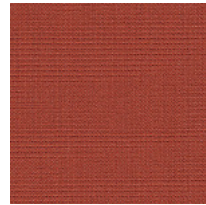

Stoff CS - Crisp / Gabriel
Colori disponibili: 10



Stoff RM - Remix 3 /
Kvadrat
Colori disponibili: 10



Stoff CH - Chili / Gabriel
Colori disponibili: 10

Sitz und Rückenlehne mit technischer Membran



Stoff BN - Bondai /
FiDiVi
Colori disponibili: 10

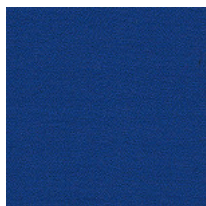

Stoff AB - Xtreme Plus /
Camira
Colori disponibili: 10



Stoff ME - Medley /
Gabriel
Colori disponibili: 15

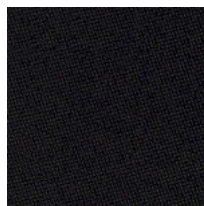

Stoff CH - Chili / Gabriel
Colori disponibili: 10



Stoff CS - Crisp / Gabriel
Colori disponibili: 10



Stoff RM - Remix 3 /
Kvadrat
Colori disponibili: 10

Questo prodotto è garantito 5 anni. Sitland Spa si riserva di apportare modifiche e/o migliorie di carattere tecnico ed estetico ai propri modelli e prodotti in qualsiasi momento e senza preavviso. Le foto e i colori visualizzati sono puramente indicativi e possono variare rispetto alla realtà. Per maggiori informazioni si prega di contattare il nostro Servizio Clienti service@sitland.com