

sitland

General Catalog

—

sitland

Summary

—

SITLAND	5
INSPIRATION	7
FUNCTIONAL SHEETS	95
COLLECTIONS	117
DESIGNERS	409
INDEX	413
CREDITS	420

SITLAND

IT

Sitland, essenza del design. Nata e sviluppata a Vicenza, città del Palladio nel cuore del Veneto, da oltre 40 anni Sitland concilia un profondo know-how tipico del Made in Italy con i processi industriali e tecnologici più innovativi, per la produzione di sedute per uffici e spazi pubblici. Grazie a qualità, ricerca ed innovazione, i nostri prodotti, 100% made in Sitland, sono stati premiati con i più importanti riconoscimenti internazionali di design. Dal 2020 Sitland ha intrapreso un percorso per la definizione di un proprio modello di economia circolare, dove la Sostenibilità è al centro di tutte le sue attività. Un nuovo modo di fare impresa e pensare il prodotto, partendo dalla progettazione, prediligendo l'impiego di materiali certificati, da fonte rinnovabile e con contenuto riciclato, minimizzando la produzione di rifiuti ed i consumi energetici, ponendo l'attenzione sulla riciclabilità dei prodotti, al fine di perseguire le migliori scelte in relazione al loro ciclo di vita.

EN

Sitland, the essence of design. Founded and developed in Vicenza, the city of Palladio in the heart of Veneto, for over 40 years Sitland has been combining a profound know-how typical of "Made in Italy" with the most innovative industrial and technological processes for the production of chairs for offices and public spaces. Thanks to quality, research, and innovation, our products, 100% made in Sitland, have won the most important international design awards. Since 2020, Sitland has embarked on a journey to define its own circular economy model, where sustainability is at the centre of all its activities. A new way of doing business and thinking about the product, starting from the design phase, prioritizing the use of certified materials, from renewable sources and with recycled content, minimizing the production of waste and energy consumption, focusing on the recyclability of the products, in order to make the best choices regarding their life cycle.

DE

Sitland, die Essenz des Designs. Gegründet und entwickelt in Vicenza, der Stadt von Palladio im Herzen Venetiens, kombiniert Sitland seit über 40 Jahren ein tiefgehendes Know-how, das typisch für "Made in Italy" ist, mit den innovativsten industriellen und technologischen Prozessen für die Herstellung von Sitzmöbeln für Büros und öffentliche Räume. Dank der Qualität, Forschung und Innovation wurden unsere Produkte, die zu 100 % in Sitland hergestellt werden, mit den wichtigsten internationalen Designpreisen ausgezeichnet. Seit 2020 hat Sitland einen Weg eingeschlagen, um ein eigenes Kreislaufwirtschaftsmodell zu definieren, bei dem Nachhaltigkeit im Mittelpunkt all seiner Tätigkeiten steht. Eine neue Art, Geschäfte zu machen und über das Produkt nachzudenken, beginnend mit dem Design, die Verwendung zertifizierter Materialien aus erneuerbaren Quellen und mit recyceltem Inhalt zu bevorzugen, die Abfallerzeugung und den Energieverbrauch zu minimieren und sich auf die Recyclingfähigkeit der Produkte zu konzentrieren, um die besten Entscheidungen in Bezug auf ihren Lebenszyklus zu treffen.

FR

Sitland, l'essence du design. Née et développée à Vicence, ville de Palladio dans le cœur de la Vénétie, Sitland allie depuis plus de 40 ans un profond savoir-faire, typique du Made in Italy, et des processus industriels et technologiques les plus innovants, pour la production de chaises destinées aux bureaux et espaces publics. Grâce à sa qualité, à la recherche et à l'innovation, nos produits, 100% made in Sitland, ont été récompensés avec les prix internationaux les plus importants du design. Depuis 2020, Sitland a entrepris un parcours pour la définition de son modèle d'économie circulaire, où la Durabilité est au centre de toutes ses activités. Une nouvelle façon d'entreprendre et de penser le produit, en partant de la conception, en privilégiant l'utilisation de matériaux certifiés, issus de sources renouvelables et ayant un contenu recyclé, en minimisant la production de déchets et les consommations d'énergie, en accordant une attention à la recyclabilité des produits, afin d'effectuer les meilleurs choix concernant leur cycle de vie.

ES

Sitland, esencia del diseño. Fundada y desarrollada en Vicenza, la ciudad de Palladio, en el corazón de la región del Veneto, Sitland lleva más de 40 años combinando un profundo know-how típico del Made in Italy con los procesos industriales y tecnológicos más innovadores para la producción de asientos para oficinas y espacios públicos. Gracias a la calidad, la investigación y la innovación, nuestros productos, 100 % made in Sitland, han recibido los más importantes premios internacionales de diseño. Desde 2020, Sitland ha emprendido un camino para definir su propio modelo de economía circular, en el que la sostenibilidad está en el centro de todas sus actividades. Una nueva forma de hacer negocios y de pensar en los productos, a partir del diseño, favoreciendo el uso de materiales certificados, de fuentes renovables y con contenido reciclado, minimizando la producción de residuos y el consumo de energía, centrándose en la reciclabilidad de los productos, con el fin de buscar las mejores opciones en relación con su ciclo de vida.



Per ulteriori informazioni sul modello di sostenibilità e le certificazioni Sitland, scansiona il QR code

For more information on Sitland's Model of Sustainability and Certifications, scan the QR code



INSPIRATION

—





—
**Sedute dalle forme eleganti
e ben definite arredano un ambiente
caratterizzato da architetture
e materiali ricercati.**

Seatings with elegant and well-defined shapes furnish an environment characterised by sophisticated architecture and materials.



Lido Modular system Fil Coffee table Milos Lounge Armchair Tov Coffee table





Lido Modular system **Fii** Coffee table

Lido Modular system **Milos Lounge** Armchair **Tov** Coffee table







Drop Modular system







Milos Life Meeting Milos Lounge Armchair Rest Coffee table





Milos Life Meeting







Cell128 Armchair - Sofa Tov Coffee table

Team Strike Task



Of Course Executive **Classic** Manager
Canapè Armchair - 2-seater sofa **Tov** Coffee table





Of Course Executive - Manager Canapè Armchair - 2-seater sofa





Cell75 Armchair



Spirit Executive Passe-partout Visitor





Leaf Task





Lido Modular system Milos Elle 4-legs - Stool Bistrot Table - High table



Lido Modular system

Milos Elle 4-legs Bistrot Table







Vega Executive - Meeting





—
**Prodotti flessibili, ergonomici
e modulari per uno spazio ibrido dove si
alternano momenti di lavoro individuale e
di collaborazione.**

Flexible, ergonomic and modular products,
for an hybrid space where individual work
and collaboration coexist.



DO
MORE
OF
WHAT
LIKES
YOU
HAPPY

THE
FUTURE
STARTS
TODAY



Bomm Modular system







Milos Elle Stool

Lido Modular system





Drop Modular system





Drop Modular system







Use Me High table - Table Soul Meeting Joy Pouf Dodo Pouf





Use Me Table Joy Pouf



Use Me High table





Tobi 3-seater sofa **Rest** Coffee table

Milos Lounge Armchair **Fil** Coffee table





—
Milos Lounge Armchair **Rest** Coffee table **Tobi** 2-seater sofa - 3-seater sofa







Skate Task Joy Pouf

Bomm Modular system Dodo Pouf Use Me Table







Why Not Executive - Manager









Milos Tallor Stool Milos Elle Stool Tab High table Tobl Armchair - 2-seater sofa Tov Coffee table



Milos Tallor Stool

Tobi Armchair - 2-seater sofa Tov Coffee table



Milos Elle Stool Tab High table Tobi Armchair - 2-seater sofa
Tov Coffee table



FUNCTIONAL SHEETS



DIREZIONALI EXECUTIVE

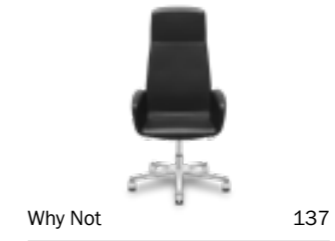
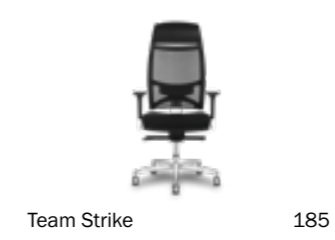



MANAGER

—

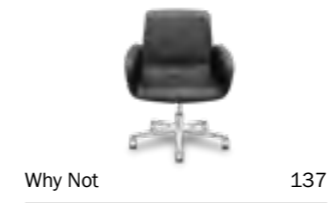
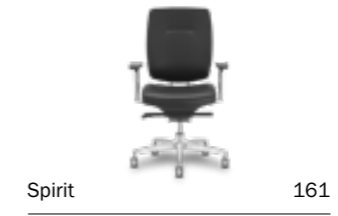
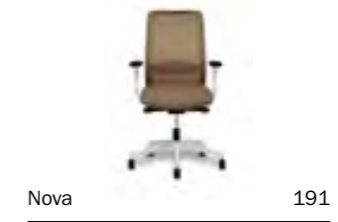
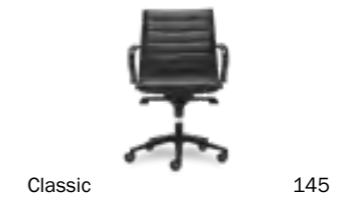



OPERATIVE TASK

—





MEETING

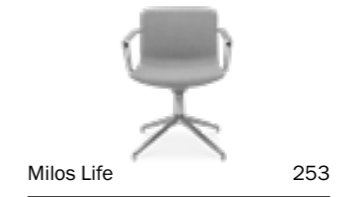
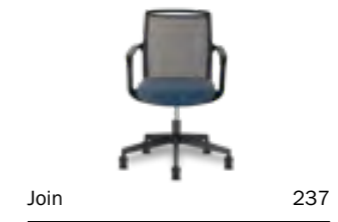
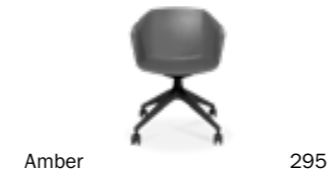



VISITATORE VISITOR

—





4 GAMBE 4-LEGS

—



Amber

295



Green'S

289



Mikado

285



Milos Elle

261



Milos Shell

275



Milos Tailor

269





SGABELLI STOOLS

—





IMBOTTITI SOFT SEATING

—



Canapè 331



Cell72 315



Cell75 321



Cell128 301

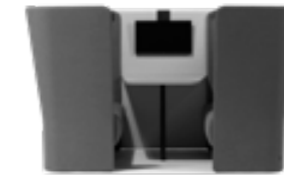

Cell Space 307



Dodo 347



Joy 343



Milos Lounge 335



Tobi 325



SISTEMI COMPONENTI MODULAR SYSTEMS

—



Bomm

351



Drop

373



Lido

363



TAVOLI TABLES

—



Bistrot

401



Fil

393



Rest

389



Tab

405



Tov

397



Use Me

383



COLLECTIONS

—





VEGA

Sergio Bellin 2013

IT

La collezione Vega offre molteplici varianti per soddisfare tutte le esigenze. Può essere minimalista ed elegante o caratterizzata da cuciture particolari, dalla personalità distintiva. Il design è informale e allo stesso tempo raffinato. La seduta è dotata di telaio interno completamente in acciaio, rivestito in poliuretano flessibile e indeformabile, con cinghie elastiche per un comfort superiore. La struttura è personalizzabile in finitura cromo e nero semi-opaco, con due tipologie di bracciolo.

EN

The Vega collection offers a host of variants to accommodate all requirements. Whether minimalist and elegant or distinguished by special stitching, packed with a distinctive personality. Its design is informal yet at the same time sophisticated. The seat is equipped with an all-steel internal frame, covered with shape-retaining flexible polyurethane, with elastic belts ensuring superior comfort. The structure can be customised with semi-matt black or chrome finish, with two types of armrest.

DE

Die Kollektion Vega bietet vielfältige Varianten, um allen Anforderungen entsprechen zu können. Sie kann minimalistisch und elegant sein oder, dank der speziellen Nähte, eine markante Persönlichkeit aufweisen. Das Design ist informell und gleichzeitig edel. Der Stuhl ist mit einem vollständig aus Stahl bestehenden Innengestell ausgestattet, das mit flexiblem und unverformbarem Polyurethan verkleidet ist und über elastische Riemen für den maximalen Komfort verfügt. Für die Struktur kann man auch individuell eine verchromte oder eine halbmatte schwarze Ausführung und zwei verschiedene Arten von Armlehnen wählen.

FR

La collection Vega offre de multiples variantes pour répondre à toutes les exigences. Les fauteuils peuvent ainsi présenter un style minimaliste et élégant ou des coutures particulières pour une touche plus personnelle. Le design est informel et en même temps raffiné. L'assise est dotée d'un châssis interne entièrement en acier, avec un rembourrage souple et indéformable, et des sangles élastiques pour un confort supérieur. La structure est personnalisable avec des finitions chrome ou noir semi-mat, et deux types d'accoudoirs.

ES

La colección Vega ofrece múltiples variantes para satisfacer todas las necesidades. Puede ser minimalista y elegante o estar caracterizada por costuras especiales, de personalidad característica. El diseño es informal y al mismo tiempo refinado. El asiento dispone de bastidor interno completamente en acero, revestido en poliuretano flexible e indeformable, con correas elásticas para un confort superior. La estructura se puede personalizar en acabado cromo y negro semimate, con dos tipos de apoyabrazos.



—
Vega Hit Manager

—
Vega Hit Executive **Vega Hit** Meeting



Vega Visitor Vega Executive



VEGA DIREZIONALE EXECUTIVE

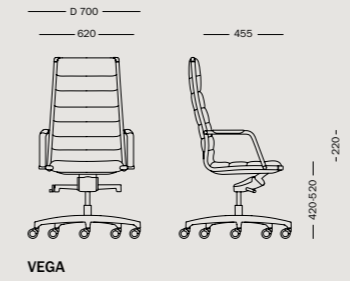

VEGA

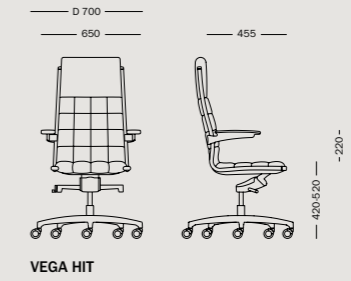

VEGA HIT

VEGA MANAGER

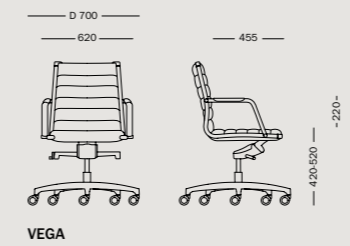

VEGA

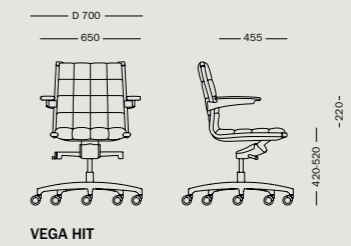

VEGA HIT

VEGA MEETING

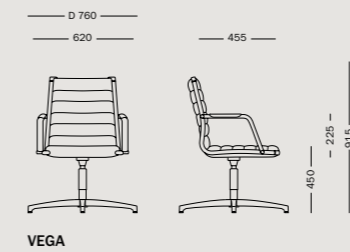

VEGA

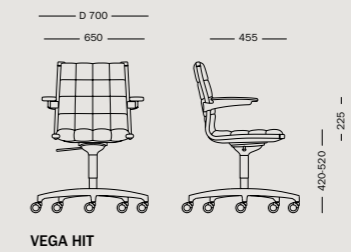

VEGA HIT

VEGA VISITATORE VISITOR

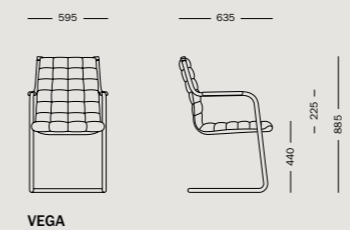

VEGA





SIT IT

Sergio Bellin, Fiorenzo Dorigo 2003

IT

Sit It è la collezione di sedute direzionali e manageriali dalla linearità strutturata, con telaio in acciaio e alluminio, proposta in diversi rivestimenti di pregio. Un classico per l'ufficio, disponibile nella versione direzionale, manageriale e meeting, che offre un comfort impeccabile, grazie ai cuscini imbottiti, realizzati con densità differenziate. L'elegante design dei braccioli si integra perfettamente nella seduta e caratterizza la collezione.

EN

Sit It is a collection of managerial and executive seats with a structured linearity, with a steel and aluminium frame, offered in various fine upholsteries. An office classic, available in the executive, managerial and meeting versions, which affords impeccable comfort, thanks to the padded cushions, made with different densities. The stylish design of the armrests blends in seamlessly with the seat, characterising the entire collection.

DE

Sit It ist eine Kollektion von Chef- und Managerstühlen mit strukturierter Linienführung, mit einem Gestell aus Stahl und Aluminium, mit diversen hochwertigen Bezügen im Angebot. Ein Klassiker für das Büro, erhältlich in den Ausführungen als Chef- und Managersessel und als Konferenz-Stühle, der dank der in unterschiedlicher Dichte gefertigten gepolsterten Kissen besten Komfort bietet. Das elegante Design der Armlehnen verbindet sich perfekt mit dem Stuhl und ist charakteristisch für die Kollektion.

FR

Sit It est la collection de fauteuils présidentiels et de direction caractérisés par des lignes structurées, avec un châssis en acier et aluminium, proposés avec différents revêtements de premier choix. Un classique pour le bureau, disponible en trois modèles (présidentiel, direction et réunion), qui offre un confort irréprochable grâce à un rembourrage différencié. Caractéristiques de la collection, les lignes élégantes des accoudoirs s'intègrent parfaitement au siège.

ES

Sit It es la colección de asientos de dirección y gestión de linealidad estructurada, con bastidor en acero y aluminio, propuesta en diversos revestimientos de valor. Un clásico para la oficina, disponible en la versión de dirección, gestión y reuniones, que ofrece un confort impecable, gracias a los cojines acolchados, realizados con densidades diferenciadas. El elegante diseño de los apoyabrazos se integra perfectamente en el asiento y caracteriza la colección.



Sit It Executive

Sit It Executive - Manager - Meeting





SIT IT DIREZIONALE EXECUTIVE

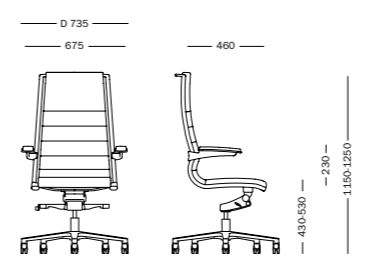

SIT IT MANAGER

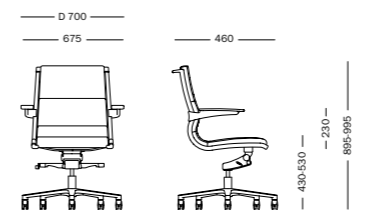

SIT IT MEETING

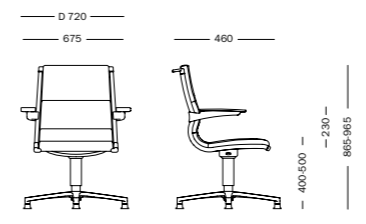



OF COURSE

Dorigo Design 2005

IT

Of Course è la collezione di sedute direzionali, manageriali e meeting dai dettagli raffinati, intramontabile classico dell'office design di prestigio. I rivestimenti pregiati, disponibili in un'ampia gamma di cromie e tessuti, vestono la seduta con cuciture artigianali, che ne risaltano le linee. La struttura interna in acciaio garantisce una sicura solidità nel tempo. L'imbottitura in poliuretano indeformabile e i suoi braccioli integrati assicurano il massimo comfort.

EN

Of Course is a collection of executive, managerial and meeting seats, oozing sophistication, a timeless classic in prestigious office design. The fine upholsteries, which are available in an extensive range of colours and fabrics, cover the seat with craft-based stitching, enhancing its silhouette. The internal steel structure guarantees durability and sturdiness over time. The shaperetaining polyurethane padding and incorporated armrests provide ultimate levels of comfort.

DE

Of Course ist eine Kollektion der mit edlen Details ausgestatteten zeitlosen Klassiker des hochwertigen Office-Designs im Bereich der Chef- und Managersessel und Konferenzstühle. Die in einer breit gefächerten Farb- und Stoffpalette erhältlichen hochwertigen Bezüge zieren die Stühle mit handwerklich gefertigten Nähten, die die Linienführung betonen. Die Innenstruktur aus Stahl garantiert eine langfristige Haltbarkeit. Die Polsterung aus unverformbarem Polyurethan und die integrierten Armlehnen gewährleisten ein Maximum an Komfort.

FR

Of Course est la collection de fauteuils présidentiels, de direction et de réunion, aux détails raffinés, un classique éternel de l'office design de prestige. Les revêtements de première qualité disponibles dans une vaste gamme de couleurs et de tissus habillent l'assise avec des coutures artisanales mettant en valeur les lignes du fauteuil. La structure interne en acier garantit une bonne solidité dans le temps. Le rembourrage en polyuréthane indéformable et ses accoudoirs intégrés assurent un confort maximal.

ES

Of Course es la colección de asientos de dirección, gestión y reunión de detalles refinados, eterno clásico del diseño de oficina de prestigio. Los revestimientos de calidad, disponibles en una amplia gama de colores y tejidos, visten el asiento con costuras artesanales que resaltan las líneas. La estructura interna en acero garantiza una segura resistencia en el tiempo. El relleno en poliuretano indeformable y sus apoyabrazos integrados aseguran el máximo confort.



Of Course Executive

Of Course Manager - Meeting



Of Course Visitor



OF COURSE DIREZIONALE EXECUTIVE

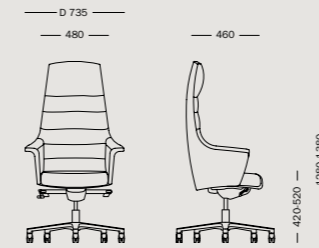

OF COURSE MANAGER

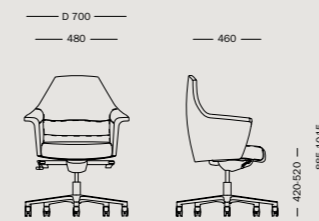

OF COURSE MEETING

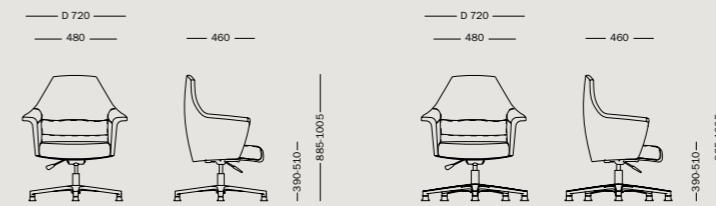

OF COURSE VISITATORE VISITOR

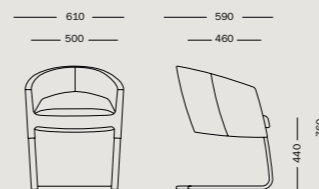



WHY NOT

Dorigo Design 2019

IT

Why Not è un progetto che nasce per offrire una seduta dalle proprietà tipiche delle sedute tecniche ma capace di adattarsi anche alle esigenze del living con un linguaggio fresco e dinamico. La struttura monoscocca integra nel sedile una meccanica che permette la regolazione dell'angolo dello schienale in tre posizioni per offrire sempre il massimo del comfort. Il blocco della posizione dello schienale e la regolazione in altezza del sedile avvengono attraverso due discrete leve.

EN

Why Not was created to offer a chair with the typical characteristics of technical chairs but which can also adapt to the requirements of living spaces with its new dynamic appeal. The single structure has a mechanism integrated into the seat that allows the backrest tilt to be adjusted to three positions, always providing maximum comfort. Two discreet levers lock the backrest into position and adjust the seat height.

DE

Why Not ist ein Projekt, das geboren wurde, um einen Sitz mit den typischen Eigenschaften technischer Sitze anzubieten, der sich jedoch mit einem frischen und dynamischen Ausdruck auch an die Bedürfnisse des Wohnzimmers anpassen kann. Die Monocoque-Struktur integriert einen Mechanismus in den Sitz, mit dem der Winkel der Rückenlehne in drei Positionen eingestellt werden kann, um immer maximalen Komfort zu bieten. Die Position der Rückenlehne und die Sitzhöhe werden durch zwei diskrete Hebel eingestellt.

FR

Why Not a été créé pour offrir une assise dotée des caractéristiques typiques des sièges techniques tout en s'adaptant aux exigences des espaces de vie grâce à son dynamisme novateur. La structure unique possède un mécanisme intégré dans le siège qui permet de régler l'inclinaison du dossier sur trois positions, offrant toujours un confort maximal. Deux leviers discrets verrouillent le dossier en position et règlent la hauteur de l'assise.

ES

Why Not es un proyecto nacido para ofrecer un asiento con las propiedades típicas de los asientos técnicos pero capaz de adaptarse también a las necesidades de la sala de estar con un lenguaje fresco y dinámico. La estructura monocasco integra un mecanismo en el asiento que permite el ajuste del ángulo del respaldo en tres posiciones para ofrecer siempre la máxima comodidad. La posición del respaldo y la altura del asiento se ajustan a través de dos palancas discretas.

PREMI AWARDS

Good Design 2021



Why Not Meeting - Manager



WHY NOT DIREZIONALE EXECUTIVE

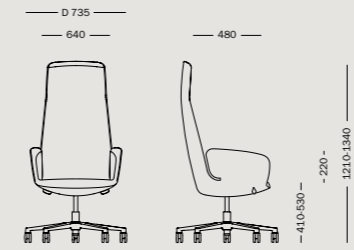

WHY NOT MANAGER

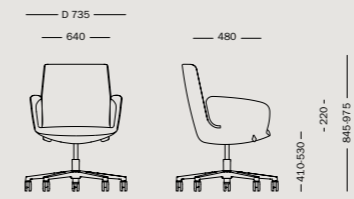

WHY NOT MEETING

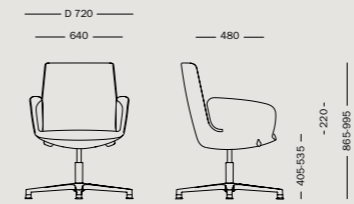



BODY

Sergio Bellin 2007

IT

Una collezione completa, declinata nei modelli direzionale, manageriale e meeting. Body è la linea di sedute con struttura monoscocca in legno multistrato di faggio, rivestito con imbottitura sagomata ergonomica, disponibile in raffinate finiture tessili differenti, ciascuna proposta in un'ampia gamma cromatica. I braccioli in lama di acciaio, integrati nella struttura, completano l'elegante design, rivestiti nella stessa finitura della seduta.

EN

A complete collection with executive, managerial and meeting models available. Body is the line of seating with single-shell structure in beech plywood, covered with shaped and ergonomic upholstery, available in sophisticated different textile finishes, each one proposed in a wide colour range. The steel blade armrests, built into the structure, add to the elegant design, covered in the same finish as the seat.

DE

Eine komplette Kollektion, angeboten in den Modellen für Geschäftsleitung, Management und Meeting. Die Linie Body besteht aus Sitzschalen, hergestellt aus Buchensperrholz, überzogen mit körpergerecht geformter Polsterung, erhältlich in verschiedenen, hochwertigen Stoffen, alle in einer umfangreichen Farbpalette angeboten. Die in die Struktur integrierten Armlehnen aus Stahlblech vervollständigen das elegante Design und sind in der gleichen Stoffvariante der Sitzschale ausgeführt.

FR

Une collection complète, déclinée dans les modèles direction, management et réunion. Body est la ligne de sièges avec structure monocoque en multiplis de hêtre, revêtue d'un rembourrage galbé ergonomique, disponible dans des finitions textiles différentes et raffinées, proposée chacune dans une vaste gamme chromatique. Les accoudoirs en lame d'acier, intégrés dans la structure, complètent l'élégant design, et sont revêtus dans la même finition que l'assise.

ES

Una colección completa compuesta por modelos de dirección, operativos y de confidente. Body es la línea de sillas con estructura monocasco de madera estratificada de haya, revestida con acolchado perfilado ergonómico, disponible en diferentes acabados textiles refinados, cada propuesta se presenta en una amplia gama de tonalidades. Los apoyabrazos en lámina de acero integrados en la estructura completan el diseño elegante, revestidos en el mismo acabado de la silla.

Body Manager - Meeting



BODY DIREZIONALE EXECUTIVE

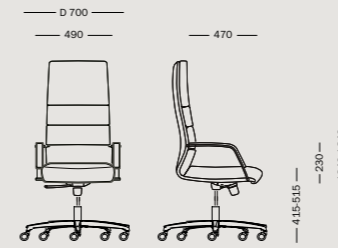

BODY MANAGER

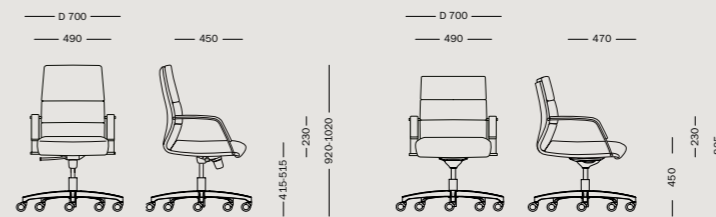

BODY MEETING

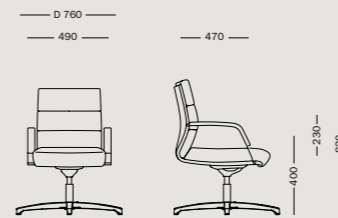



CLASSIC

Sergio Bellin 2010

IT

La collezione Classic arreda lo spazio ufficio con sedute direzionali con schienale alto, sedute manageriali e meeting con piedini fissi, caratterizzate da un design essenziale e rivestimenti pregiati, in numerose varianti cromatiche. Il telaio, in acciaio cromato o verniciato nero opaco, è completato dal basamento a cinque razze disponibile nelle finiture alluminio lucido e alluminio nero opaco.

EN

The Classic collection furnishes the office space with high-backed executive seating, managerial and meeting seating with fixed feet, featuring an understated design and luxury covers in numerous colour versions. The frame, in chromed steel or matte black coated, also has a base with five spokes available in matte black aluminium and gloss aluminium finishes.

DE

Die Kollektion Classic besteht aus Bürostühlen mit hoher Rückenlehne für das Direktionsbüro und Stühlen mit fixen Füßen für Management und Meeting, die sich durch minimalistisches Design und hochwertige Bezüge auszeichnen, alle in zahlreichen, farblichen Varianten. Das verchromte oder schwarz matt lackierte Stahlgestell wird durch ein fünfstrahliges Fußkreuz in den Ausführungen Aluminium glänzend und Aluminium matt schwarz komplettiert.

FR

La collection Classic meuble l'espace bureau avec des fauteuils de direction à dossier haut, des fauteuils management et réunion sur patins fixes, tous caractérisés par un design essentiel et des revêtements de qualité, en de nombreuses déclinaisons chromatiques. La structure, en acier chromé ou laqué noir mat, est complétée par un piètement à cinq branches disponible dans les finitions aluminium poli et aluminium noir mat.

ES

La colección Classic amuebla la oficina con sillas de dirección de respaldo alto, sillas operativas y de confidente con patas fijas. Se caracterizan por un diseño esencial y revestimientos refinados en numerosas variantes cromáticas. El bastidor es de acero cromado o pintado negro mate y se completa con base de cinco radios disponible en los acabados de aluminio brillo y aluminio negro mate.



Classic Executive

Classic Executive Classic+ Manager





CLASSIC DIREZIONALE EXECUTIVE

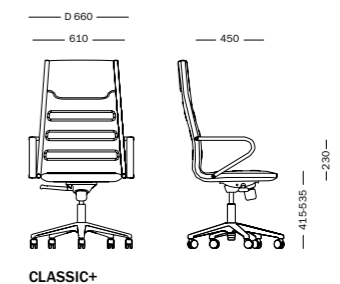
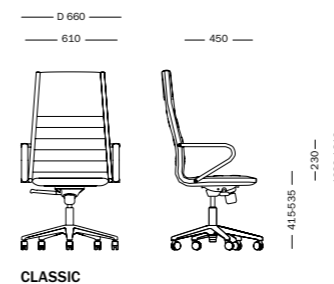

CLASSIC MANAGER

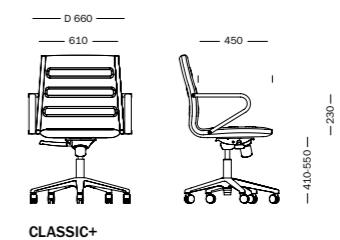
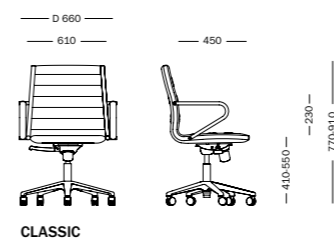

CLASSIC MEETING

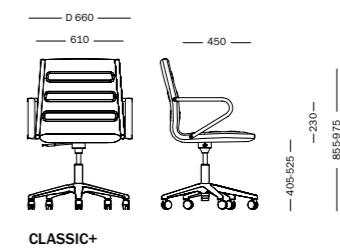
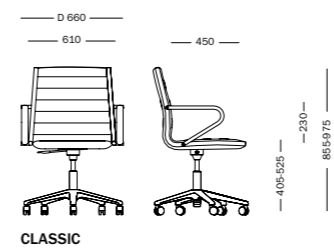

CLASSIC VISITATORE VISITOR

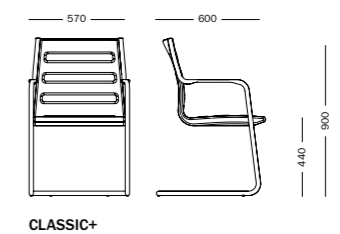
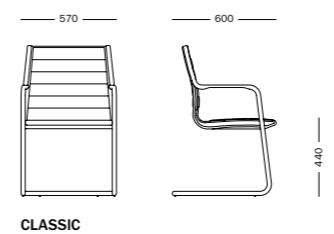



LINE

Sergio Bellin 2017

IT

Line è la collezione di sedute direzionali, manageriali e meeting, con eleganti braccioli a sbalzo e seduta extrasottile dal design distintivo, impreziosito da rivestimenti in finiture di pregio, in versione liscia o caratterizzata da cuciture orizzontali. Line è disponibile con diverse tipologie di meccanismo e nella versione sgabello.

EN

Line is the collection of executive, managerial and meeting seats, with elegant cantilevered armrests and ultra-slim seat with distinctive design, embellished by upholstery in luxury finishes, in plain version or featuring horizontal stitching. Line is available with different types of mechanism and in the stool version.

DE

Line ist eine luxuriöse Kollektion von Sitzmöbeln für Geschäftsleitung, Management, Meeting: elegante, ausladende Armlehnen, extraschlanke Sitzflächen im exklusiven Design, veredelt durch kostbare Ausfertigung, in den Ausführungen glatt oder mit horizontalen Nähten. Line ist mit verschiedenen Mechanismen und in einer Hockerversion erhältlich.

FR

Line est la collection de fauteuils de direction, management et réunion, avec d'élégants accoudoirs en porte-à-faux et une assise extra-fine au design reconnaissable, enrichie par les finitions de qualité des revêtements, dans la version lisse ou avec coutures horizontales. Line est disponible avec plusieurs typologies de mécanisme et dans une version tabouret.

ES

Line es la colección de sillas de dirección, operativas y de confidente, con apoyabrazos elegantes en voladizo y asiento muy fino de diseño peculiar, embellecido por revestimientos en acabados preciosos, en versión lisa o caracterizada por costuras horizontales. Line dispone de distintos tipos de mecanismos, en la versión taburete.



Line Executive

Line Executive - Meeting





LINE DIREZIONALE EXECUTIVE

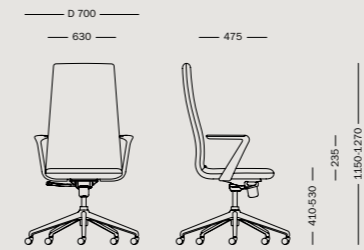

LINE MANAGER

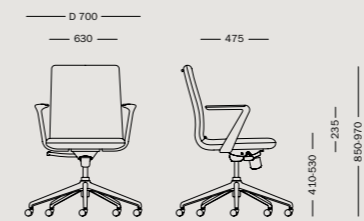

LINE MEETING

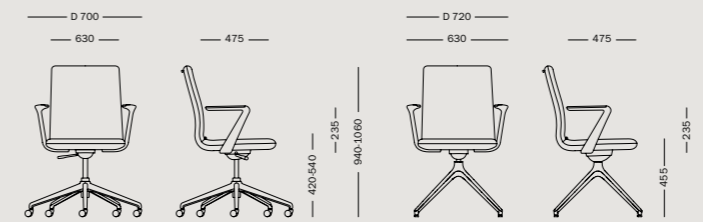

LINE SGABELLO STOOL

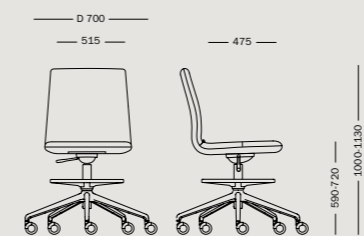



ICE

Sergio Bellin 2009

IT

Ice è la collezione di sedute per uffici direzionali e manageriali, completata anche da un modello adatto a sale riunioni e sale d'attesa. Caratterizzata dal fine rivestimento in rete traspirante colore nero, Ice è disegnata da un essenziale telaio esterno in tubo d'acciaio, disponibile in finitura cromato o nero. I braccioli integrati nella struttura sono coordinati alla seduta, con possibilità di rivestimento top in tre diverse finiture.

EN

Ice is the collection of seating for executive and managerial offices, also including a model suitable for meeting rooms and waiting rooms. Featuring a fine covering in black breathable mesh, Ice is outlined by an understated outer frame in tubular steel, available in chromed or black finish. The armrests built into the structure are coordinated with the seat, with the possibility of top upholstery in three different finishes.

DE

Ice ist eine Kollektion von Sitzmöbeln für das Direktions- und Managementbüro, vervollständigt durch ein Modell für Sitzungs- und Besucherräume. Ice, geprägt durch den edlen, atmungsaktiven Netzbezug in schwarzer Farbe, zeichnet sich durch ein minimalistisches, außen liegendes Stahlrohrgestell aus, das in der Ausführung verchromt oder schwarz erhältlich ist. Die in die Struktur integrierten Armlehnen sind auf die Sitzfläche abgestimmt, Überzüge der Oberseite in drei verschiedenen Ausführungen.

FR

Ice est la collection de sièges pour bureaux de direction et management, complétée également par un modèle adapté aux salles de réunion et aux salles d'attente. Caractérisée par un fin revêtement en maille filet respirante de couleur noire, Ice est constituée d'une structure essentielle en tube d'acier, disponible dans la finition chromée ou noir. Les accoudoirs intégrés dans la structure sont coordonnés avec l'assise, avec revêtement supérieur disponible en trois finitions différentes.

ES

Ice es la colección de sillas para oficinas de dirección y operativas, que se completa también con un modelo apto a las salas de reunión y de espera. Caracterizada por el revestimiento fino en malla transpirable de color negro, Ice se caracteriza por un bastidor externo esencial en tubo de acero, disponible en acabado cromado o negro. Los apoyabrazos integrados en la estructura están coordinados con el asiento, con posibilidad de revestimiento de alta calidad en tres acabados diferentes.

Ice Executive - Manager



ICE DIREZIONALE EXECUTIVE

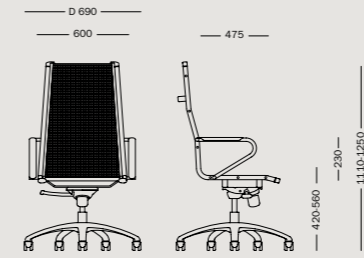

ICE MANAGER

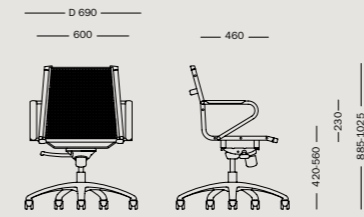

ICE MEETING

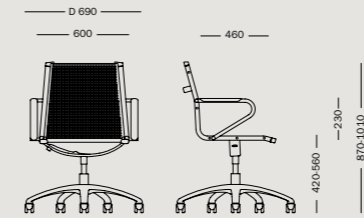



SPIRIT

Baldanzi & Novelli 2003

IT

Spirit è la seduta operativa e direzionale nata per garantire un'assoluta eccellenza posturale nelle ore lavorative e per utilizzi di lungo corso. Lo schienale è dotato di meccanismo brevettato Freedom, per seguire perfettamente il movimento dell'utente. Spirit offre una regolazione dell'angolo del sedile molto ampia, unica nella sua tipologia. Il sedile può essere regolato in profondità nella posizione desiderata o messo in posizione libera, per la massima ergonomia.

EN

Spirit is an operational and executive seat devised to ensure absolute postural excellence during work hours and long-term use. The back is fitted with a patented Freedom mechanism, which plies to the user's every movement to perfection. Spirit offers a very generous seat angle adjustment, making it unique in its category. The seat can be depth-adjusted to the desired position or left in its free position, for maximum ergonomics.

DE

Spirit ist der Arbeitsstuhl und Chefsessel für eine hervorragende Körperhaltung während der langen Arbeitsstunden. Die Rückenlehne ist mit dem patentierten Freedom-Mechanismus ausgestattet, der sich perfekt an die Bewegungen des Benützers anpasst. Spirit bietet viele Möglichkeiten der Winkleinstellung der Sitzfläche, die in ihrer Art einzigartig sind. Die Sitzfläche kann in der Tiefe in der gewünschten Position eingestellt werden oder für die maximale Ergonomie in eine freie Position gebracht werden.

FR

Spirit est un fauteuil opérationnel présidentiel conçu pour garantir une posture absolument parfaite pendant les heures de travail et pour les utilisations longue durée. Le dossier est doté d'un mécanisme breveté Freedom, pour suivre à la perfection le mouvement de l'utilisateur. Spirit offre de vastes possibilités de réglage de l'angle de l'assise, uniques dans sa typologie. Le siège peut être réglé en profondeur dans la position souhaitée ou en position libre, pour une ergonomie optimale.

ES

Spirit es el asiento operativo y de dirección nacido para garantizar una absoluta calidad de la postura durante las horas laborables y para usos de larga duración. El respaldo dispone de mecanismo patentado Freedom, para seguir perfectamente el movimiento del usuario. Spirit ofrece una regulación del ángulo del asiento muy amplio, única en su tipología. El asiento se puede regular en profundidad en la posición deseada o colocarse en posición libre, para la máxima ergonomía.

Spirit Executive - Manager



Spirit Air Executive - Manager





SPiRiT DIREZIONALE EXECUTIVE

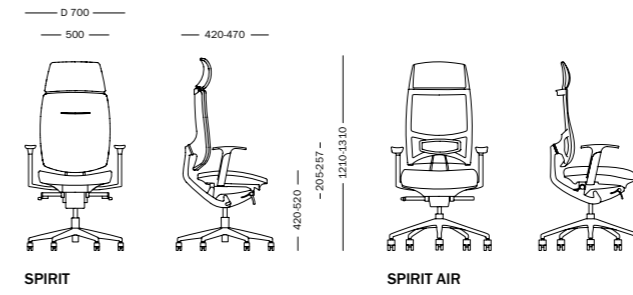

SPiRiT MANAGER

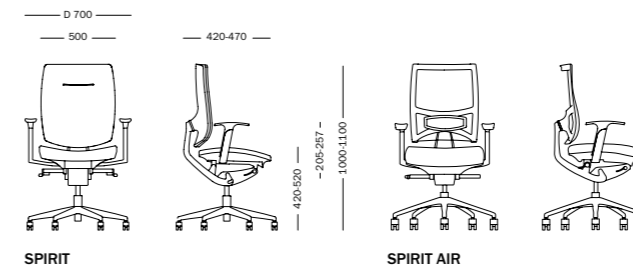



SKATE

Paolo Scagnellato, Emanuele Bertolini, Jeremiah Ferrarese 2020



IT

Skate favorisce il benessere fisico, senza sforzo e in qualsiasi momento. Concepita per stimolare il movimento anche stando seduti, Skate è dotata di un sistema di oscillazione originale brevettato da Sitland: il DAT®. Il sistema DAT® Dynamic Adaptive Technology, consente a sedile e schienale di oscillare seguendo liberamente il dinamismo del corpo pur mantenendo sempre una postura adeguata. Come lo skater, l'utilizzatore di Skate non ha bisogno di leve e manopole per la regolazione dell'oscillazione ma tutto avviene in sintonia con i propri movimenti e in base al proprio peso corporeo.

EN

Skate promotes physical wellbeing, effortlessly and at any time. Designed to stimulate movement even while seated, Skate is equipped with an original oscillation system patented by Sitland: DAT®. DAT® Dynamic Adaptive Technology system allows the seat and backrest to oscillate freely following the dynamism of the body while always maintaining an adequate posture. Like the skater, Skate user does not need levers and knobs to adjust the swing but everything happens in harmony with their movements and according to their body weight.

DE

Skate fördert das körperliche Wohlbefinden, mühelos und jederzeit. Skate wurde entwickelt, um die Bewegung auch im Sitzen zu stimulieren. Es ist mit einem von Sitland patentierten Original-Schwinkungssystem ausgestattet: dem DAT®. Das DAT® Dynamic Adaptive Technology-System ermöglicht es dem Sitz und der Rückenlehne, der Dynamik des Körpers entsprechend zu schwingen und dabei stets eine angemessene Körperhaltung beizubehalten. Wie der Skater benötigt der Skate-Benutzer keine Hebel und Knöpfe, um den Schwung einzustellen, aber alles geschieht im Einklang mit seinen Bewegungen und seinem Körpergewicht.

FR

Skate favorise le bien-être physique, sans effort et à chaque instant. Conçu pour stimuler le mouvement même en position assise, Skate est équipé d'un système d'oscillation original breveté par Sitland: le DAT®. Le système DAT® Dynamic Adaptive Technology permet à l'assise et au dossier d'osciller librement en fonction de la dynamique du corps, tout en maintenant une posture appropriée. Comme le skater, l'utilisateur de Skate n'a pas besoin de leviers ni de boutons pour régler le balancement, tout se passe en harmonie avec ses mouvements et le poids de son corps.

ES

Skate promueve el bienestar físico, sin esfuerzo y en cualquier momento. Diseñada para estimular el movimiento incluso estando sentados, Skate está equipada con un sistema de oscilación original patentado por Sitland: el DAT®. El sistema DAT® Dynamic Adaptive Technology permite que el asiento y el respaldo oscilen libremente siguiendo el dinamismo del cuerpo manteniendo siempre una postura adecuada. Al igual que el patinador, el usuario de Skate no necesita palancas para ajustar la oscilación sino que todo sucede en armonía con sus movimientos y de acuerdo con su peso corporal.







SKATE OPERATIVA TASK

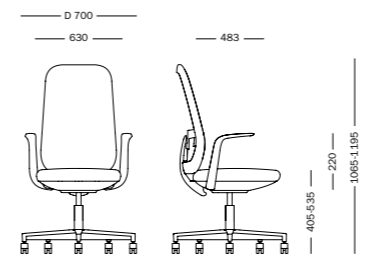



LEAF

Sergio Bellin 2008

IT

Leaf è la collezione disegnata sull'originale linearità della foglia e delle sue nervature. Il rivestimento dello schienale è realizzato in membrana elastica e può essere abbinato a diverse tipologie di tessuti o dotato di reti traspiranti. L'innovativo sistema di applicazione dello schienale garantisce una forte adattabilità alla postura dell'utente. Il sedile in schiumato ad alto spessore garantisce un comfort superiore; possibilità di regolazione anche in profondità nella posizione desiderata o in posizione libera per un'ergonomia personalizzata.

EN

Leaf is a collection designed around the original linearity of the leaf and its nerves. The back upholstery is made with an elastic membrane that can be teamed with different types of fabric or fitted with breathable mesh. The innovative system for the application of the seat back guarantees maximum adaptability to the user's posture. The seat made of extra-thick foam guarantees superior comfort; it allows depth-adjustment to the desired position or free floating for customised ergonomics.

DE

Leaf ist eine Kollektion, die die Linienführung eines Blattes und seiner Blattadern zum Thema hat. Der Bezug der Rückenlehne besteht aus einer elastischen Membran, die mit verschiedenen Gewebearten oder mit atmungsaktivem Netzstoff kombiniert werden kann. Das innovative Befestigungssystem der Rückenlehne gewährleistet eine wirkungsvolle Anpassung an die Körperhaltung des Benützers. Die aus einem dicken Schaumstoff bestehende Sitzfläche gewährleistet einen hervorragenden Komfort und bietet umfangreiche Möglichkeiten zur Einstellung in der gewünschten Position oder in einer freien Position für eine individuelle Ergonomie.

FR

Leaf est une collection qui s'inspire de la linéarité des feuilles et de leurs nervures. Le revêtement du dossier est constitué d'une membrane élastique pouvant s'associer à différents types de tissus ou de résilles transpirantes. L'innovant système d'application du dossier garantit une parfaite adaptabilité à la posture de l'utilisateur. L'épaisseur de l'assise en mousse garantit un confort supérieur tandis que les nombreuses possibilités de réglage de l'angle permettent de régler la profondeur à la position souhaitée ou d'opter pour la position libre et une ergonomie personnalisée.

ES

Leaf es la colección diseñada sobre la original linearidad de la hoja y sus nervios. El revestimiento del respaldo en membrana elástica se combina con diversos tejidos o se realiza con redes transpirables. El innovador sistema de aplicación del respaldo garantiza adaptabilidad a la postura del usuario. El asiento realizado en espuma de grosor elevado garantiza un confort superior con posibilidad de regulación en la posición deseada o en posición free para una ergonomía personalizada.

—
Leaf Task





LEAF OPERATIVA TASK

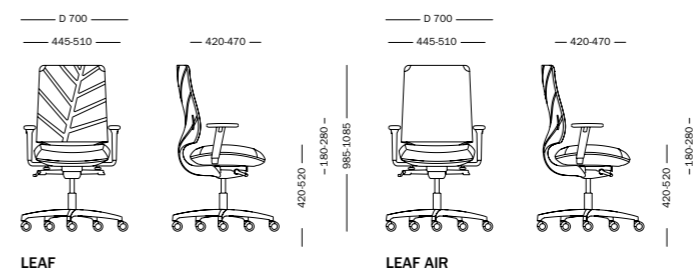



TEAM STRIKE EVO

Zakaria Khalfaoui 2023 (restyling)



IT

Non esiste evoluzione senza cambiamento. La versione Evo è la nuova reinterpretazione in chiave più sostenibile, firmata da Zakaria Khalfaoui, della nostra sedia operativa più famosa: Team Strike. Mantenendo la struttura iconica dello schienale e prediligendo l'utilizzo di materiali riciclati, abbiamo lavorato sull'integrazione dei meccanismi e su un design più minimale.

EN

There is no evolution without change. The EVO version, designed by Zakaria Khalfaoui, is the new reinterpretation in a more sustainable key, of our most famous task chair Team Strike. Maintaining the iconic structure of the backrest and preferring the use of recycled materials, we have worked on the integration of the mechanism and on a more minimal design.

DE

Es gibt keine Evolution ohne Veränderung. Die EVO-Version, entworfen von Zakaria Khalfaoui, ist die neue Neuinterpretation unseres berühmtesten Arbeitsstuhls Team Strike in einem nachhaltigeren Stil. Unter Beibehaltung der ikonischen Struktur der Rückenlehne und der bevorzugten Verwendung von recycelten Materialien haben wir an der Integration der Mechanismus und einem minimalistischeren Design gearbeitet.

FR

Il n'y a pas d'évolution sans changement. La version Evo est la nouvelle interprétation de Team Strike notre plus célèbre fauteuil de travail, dans un esprit plus durable et conçue par Zakaria Khalfaoui. Tout en conservant la structure iconique du dossier et en privilégiant l'utilisation de matériaux recyclés, nous avons travaillé sur l'intégration de mécanismes et un design plus minimaliste.

ES

No hay evolución sin cambio. La versión Evo es la nueva reinterpretación en clave más sostenible, diseñada por Zakaria Khalfaoui, de nuestra silla operativa más famosa: Team Strike. Manteniendo la estructura icónica del respaldo y privilegiando el uso de materiales reciclados, hemos trabajado en la integración de los mecanismos y en un diseño más minimalista.







TEAM STRIKE EVO DIREZIONALE EXECUTIVE

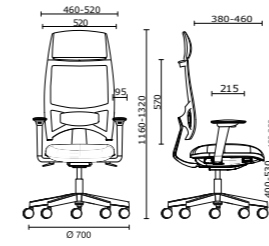

UNI EN 1335:2020-A

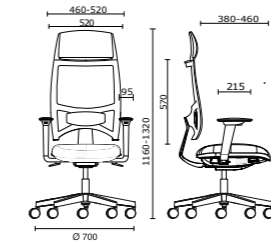

UNI EN 1335:2020-AX

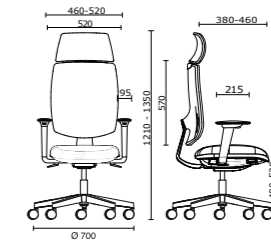

UNI EN 1335:2020-A

TEAM STRIKE EVO OPERATIVA TASK

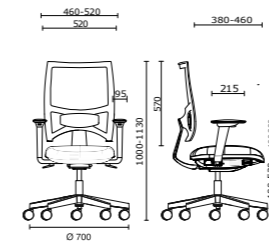

UNI EN 1335:2020-A

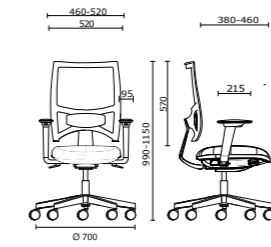

UNI EN 1335:2020-AX

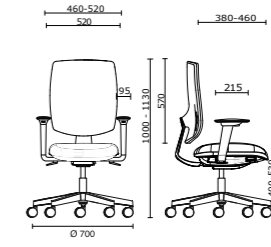

UNI EN 1335:2020-A





TEAM STRIKE

Sergio Bellin 2008

IT

Complicità nei movimenti, con sistema sincronizzato di regolazione dell'angolazione tra sedile e schienale, cinque posizioni selezionabili e sistema anti-shock. Team Strike è la seduta regolabile secondo esigenza. Studiata per garantire la riduzione dell'affaticamento muscolare e assicurare una postura corretta, è completata da un supporto lombare regolabile, schienale traspirante e seduta imbottita indeformabile con tecnologia Comfort-Air.

EN

An aid to movement, with a synchronised system of adjustment of the angle between seat and back, with a selection of five positions and anti-shock system. Team Strike is a seat that can be adjusted as required. Designed to reduce muscle fatigue and ensure correct posture, it also has adjustable lower back support, a breathable back and shaperetaining upholstered seat with Comfort-Air technology.

DE

Zusammenwirken der Bewegungen, mit Synchron- Systemen zur Verstellung des Neigungswinkels zwischen Sitz und Rückenlehne, Wahl zwischen fünf Positionen und Antischocksystem. Der Sessel Team Strike ist verstellbar. Er wurde entwickelt, um die Ermüdung der Muskeln zu reduzieren und eine korrekte Sitzhaltung zu ermöglichen, komplett mit verstellbarer Lendenstütze, atmungsaktiver Rückenlehne und Sitzfläche mit formbeständiger Polsterung durch Technologie Comfort-Air.

FR

Complicité dans les mouvements, avec système synchronisé de réglage de l'angle entre l'assise et le dossier, choix entre cinq positions et système antichoc. Team Strike propose une assise réglable suivant les exigences. Étudié pour garantir la réduction de la fatigue musculaire et assurer une posture correcte, le fauteuil est complété par un support lombaire réglable, un dossier respirant et une assise rembourrée indéformable avec technologie Comfort-Air.

ES

Complicidad en los movimientos, con el sistema sincronizado de regulación del ángulo entre el asiento y el respaldo. Posibilidad de seleccionar cinco posiciones y sistema de seguridad antigolpeo. La silla Team Strike se regula adaptándose a las exigencias del usuario. Estudiada para garantizar la reducción del cansancio muscular y mantener una postura corporal correcta, se completa con un soporte lumbar regulable, respaldo transpirable y asiento acolchado indeformable con tecnología Comfort-Air.



Team Strike Executive



Team Strike Task





TEAM STRIKE DIREZIONALE EXECUTIVE

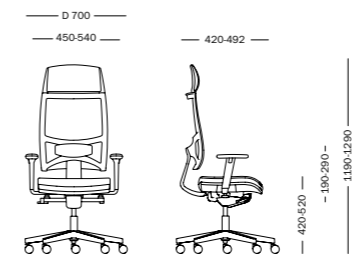

TEAM STRIKE OPERATIVA TASK

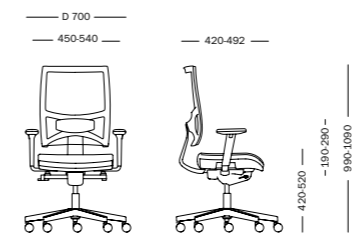



NOVA

—
D 20

—
IT

Design semplice ed ergonomia elevata. Nova introduce una ventata di innovazione e comfort nel vostro spazio di lavoro. Disponibile come sedia operativa e sgabello, Nova si adatta alle vostre esigenze, indipendentemente dall'attività o dal tipo di mansione, garantendo un benessere duraturo anche quando si lavora per molte ore alla scrivania. Ideata per fornire un supporto ergonomico eccezionale, è possibile personalizzare facilmente il vostro livello di comfort scegliendo tra due diversi meccanismi sincronizzati.

—
EN

A fusion of sleek design and superior ergonomics. Nova brings a burst of innovation and comfort into your workspace. Available as a task chair and stool, Nova adapts to your needs, regardless of your activity or type of work, ensuring long-lasting well-being even when working many hours at your desk. Designed to provide exceptional ergonomic support, you can easily customise your comfort level by choosing between two different synchronised mechanisms.

—
DE

Eine Verschmelzung von schlankem Design und überlegener Ergonomie. Nova bringt einen Hauch von Innovation und Komfort in Ihren Arbeitsbereich. Nova ist als Arbeitsstuhl und Hocker erhältlich und passt sich an Ihre Bedürfnisse an, unabhängig von Ihrer Tätigkeit oder Art der Arbeit, und sorgt für lang anhaltendes Wohlbefinden, auch wenn Sie viele Stunden am Schreibtisch arbeiten. Nova wurde für eine außergewöhnliche ergonomische Unterstützung entwickelt und bietet Ihnen die Möglichkeit, Ihren Komfort durch die Wahl zwischen zwei verschiedenen Synchronmechanismen anzupassen.

—
FR

Un design élégant et une ergonomie supérieure. Nova apporte un vent d'innovation et de confort dans votre espace de travail. Disponible en fauteuil et en tabouret, Nova s'adapte à vos besoins, quelle que soit votre activité ou votre type de travail, et vous assure un bien-être durable, même lorsque vous travaillez de nombreuses heures à votre bureau. Conçu pour offrir un soutien ergonomique exceptionnel, vous pouvez facilement personnaliser votre confort en choisissant parmi deux mécanismes synchronisés différents.

—
ES

Una combinación de diseño elegante y ergonomía superior. Nova aporta un estallido de innovación y confort a su espacio de trabajo. Disponible como silla de trabajo y taburete, Nova se adapta a sus necesidades, independientemente de su actividad o tipo de trabajo, garantizando un bienestar duradero incluso cuando trabaja muchas horas en su escritorio. Diseñado para proporcionar un apoyo ergonómico excepcional, puede personalizar fácilmente su nivel de comodidad eligiendo entre dos mecanismos sincronizados diferentes.







Dimensions

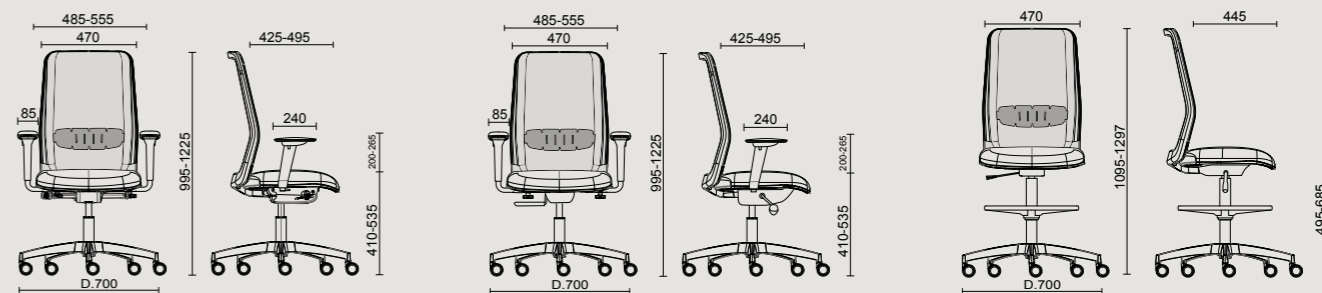



INVICTA

IT

La collezione Invicta propone una seduta completamente personalizzabile, con sistema automatico di calibratura dell'oscillazione e blocco in quattro posizioni con meccanismo antishock. Sul supporto lombare è applicabile a piacere un badge personale, removibile in qualunque momento. Nei modelli Invicta Balance e Invicta Point sono disponibili anche i rivestimenti sfoderabili copri-sedile in 11 tonalità.

EN

The Invicta collection offers seating with full personalisation possibilities, automatic system of calibrating the oscillation and locking in four positions with an anti-shock mechanism. A personal badge can be attached to the lower back support and removed at any time. The Invicta Balance and Invicta Point models are also available with removable seat covers in 11 colour shades.

DE

Sessel der Kollektion Invicta entsprechen dank automatischer Anpassung der Schwingung und Blockierung in vier Positionen mit Antishock-Mechanismus dem individuellen Bedürfnis. Auf der Lendenstütze kann beliebig ein persönliches Schild angebracht und jederzeit wieder abgenommen werden. Für die Modelle Invicta Balance und Invicta Point sind auch abnehmbare Bezüge für den Sitz in 11 verschiedenen Farben erhältlich.

FR

La collection Invicta propose une assise totalement personnalisable, avec système automatique de réglage de l'oscillation et blocage sur quatre positions avec mécanisme antichoc. Il est possible d'appliquer sur le support lombaire un badge personnalisé, qui peut être retiré à tout moment. Pour les modèles Invicta Balance et Invicta Point, des revêtements amovibles sont disponibles en 11 coloris pour recouvrir l'assise.

ES

La colección Invicta propone una silla completamente personalizable, con sistema automático para calibrar el basculamiento y bloquear la silla en cuatro posiciones con sistema de seguridad antigolpeo. En el soporte lumbar se aplica una etiqueta de identificación personal que puede quitarse en cualquier momento. Los modelos Invicta Balance e Invicta Point están disponibles también con revestimientos desfundables en 11 colores que cubren los asientos.

—
Invicta Task



INVICTA OPERATIVA TASK

— D 700 —
— 450-540 —

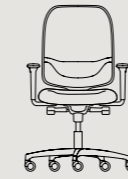

INVICTA COMFORT

— 470 —

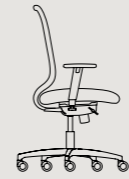

— 420-520 —
— 100-200 —
— 980-1080 —

— D 700 —
— 450-540 —



INVICTA POINT

— 440 —



— 420-520 —
— 100-200 —
— 1000-1100 —

— D 700 —
— 450-540 —

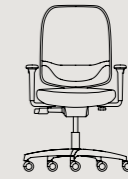

INVICTA BALANCE

— 415-465 —



— 420-520 —
— 100-200 —
— 1000-1100 —





SOFFIO

IT

Soffio assicura una corretta posizione posturale, mediante regolazione sincronizzata dell'inclinazione angolare tra sedile e schienale in cinque posizioni, con selezione manuale della tensione di oscillazione. Il supporto lombare regolabile in altezza sostiene l'affaticamento della colonna vertebrale e il sedile personalizzabile in profondità permette la selezione della posizione più confortevole. Lo schienale rivestito in rete o nella versione tappezzata garantisce traspirabilità e resistenza.

EN

Soffio ensures a correct postural position by synchronised adjustment of the angle of the slant between seat and back in five positions, with manual selection of the oscillation tension. The lower back support with height adjustment prevents spinal fatigue and the seat with custom depth allows the most comfortable position to be selected. The back covered with mesh or upholstered, guarantees breathability and strength.

DE

Soffio garantiert eine korrekte Sitzhaltung über Synchronverstellung des Neigungswinkels zwischen Sitz und Rücklehne in fünf Positionen, die Spannung der Schwingung ist manuell einstellbar. Die höhenverstellbare Lendenstütze wirkt der Ermüdung der Wirbelsäule entgegen, dank verstellbarer Sitztiefe kann die jeweils bequemste Position ausgewählt werden. Die Rückenlehne, mit Netzbezug oder in der tapezierten Ausführung, ist atmungsaktiv und strapazierfähig.

FR

Soffio assure une posture correcte grâce au réglage synchronisé de l'angle d'inclinaison entre l'assise et le dossier sur cinq positions, avec sélection manuelle de la tension d'oscillation. Le support lombaire réglable en hauteur soulage la colonne vertébrale et l'assise personnalisable en profondeur permet de sélectionner la position la plus confortable. Le dossier revêtu en maille filet, ou dans la version tissu, garantit respirabilité et résistance.

ES

Soffio asegura una postura del cuerpo correcta mediante la regulación sincronizada de la inclinación del ángulo entre el asiento y el respaldo en cinco posiciones, con selección manual de la tensión de basculamiento. El soporte lumbar de altura regulable sostiene la columna vertebral y el asiento de profundidad variable permite seleccionar la posición más cómoda. El respaldo de malla o en la versión tapizada garantiza transpirabilidad y resistencia.



—
Soffio Task





SOFFIO OPERATIVA TASK

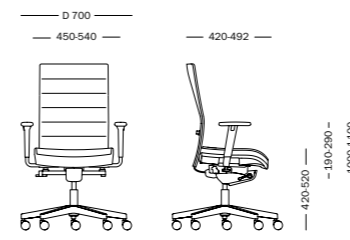



MESH LINE

IT

Sedile in poliuretano flessibile con tecnologia Comfort-Air per un'imbottitura eccellente e schienale con tecnologia Up&Down per la regolazione dell'altezza. Mesh Line è la collezione di sedute rivestite in rete tridimensionale altamente resistente e traspirante, disponibile con diverse tipologie di braccioli, basi e ruote, per la massima libertà compositiva in qualsiasi spazio operativo.

EN

Seat in flexible polyurethane with Comfort-Air technology for optimal padding and back with Up&Down technology for adjusting height. Mesh Line is the collection of seats covered in highly resistant and breathable threedimensional mesh, available with different types of armrests, bases and Casters, for maximum freedom of composition in any working space.

DE

Sitz aus flexiblem Polyurethan mit der Technologie Comfort-Air für exzellente Polsterung, Rückenlehne höhenverstellbar mit der Technologie Up&Down. Mesh Line ist die Kollektion der Sitzmöbel mit äußerst resistenten und atmungsaktiven Bezügen in 3D-Netzstruktur, erhältlich mit verschiedenen Armlehnen, Untergestellen und Rollen für viel Gestaltungsfreiheit in jedem Büro.

FR

Assise en polyuréthane flexible avec technologie Comfort-Air pour un excellent rembourrage et dossier avec technologie Up&Down pour le réglage de la hauteur. Mesh Line est la collection de sièges revêtus en maille filet 3D à haute résistance et respirabilité, disponible avec différents types d'accoudoirs, piètements et roulettes, pour la plus grande liberté de composition dans n'importe quel espace de travail.

ES

Asiento de poliuretano flexible con tecnología Comfort-Air para un acolchado excelente y respaldo con tecnología Up&Down para el ajuste de la altura. Mesh Line es la colección de asientos revestidos en malla tridimensional de gran resistencia y transpirabilidad. Equipada con distintos tipos de apoyabrazos, bases y ruedas, ofrece la máxima libertad de composición en cualquier espacio operativo.

Mesh Line Task



MESH LINE OPERATIVA TASK

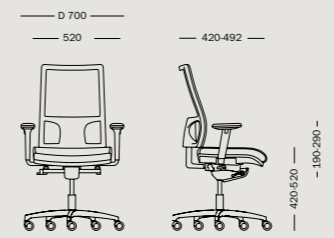



NO NAME

IT

No Name è la collezione di sedute operative dalle funzioni performanti. Disponibile con meccanismo a contatto permanente evoluto o meccanismo sincronizzato, e caratterizzata da schienale in rete altamente traspirante, può essere dotata di supporto lombare orientabile e braccioli regolabili. Il modello direzionale è completato da poggiatesta imbottito coordinato alla finitura del sedile.

EN

No Name is the collection of work seating with high-performance functions. Available with advanced permanent contact mechanism or synchronised mechanism, and featuring a back in highly breathable mesh which can be fitted with a positionable lower back support and adjustable armrests. The executive model also has a padded headrest coordinated with the seat finishes.

DE

No Name ist eine Linie von Bürostühlen leistungsstark in der Funktion. Erhältlich mit einer technisch raffinierten, stufenlosen Wippmechanik oder mit Synchronmechanismus, Bezug der Rückenlehne aus hoch atmungsaktivem Netzstoff; kann mit schwenkbarer Lendenstütze und verstellbaren Armlehnen ausgestattet werden. Der Sessel für das Direktionsbüro ist komplett mit gepolsterter Kopfstütze, die auf die Ausführung der Sitzfläche abgestimmt ist.

FR

No Name est la collection de sièges bureautiques aux fonctions performantes. Disponible avec mécanisme à contact permanent évolué ou mécanisme synchronisé, et caractérisé par un dossier en maille filet très respirant, il peut être équipé de support lombaire orientable et d'accoudoirs réglables. Le modèle de direction est complété par une tête rembourrée dans la même finition que l'assise.

ES

No Name es la colección de sillas operativas con funciones de alto rendimiento. Disponible con mecanismo de contacto permanente avanzado o mecanismo sincronizado, se caracteriza por el respaldo en malla muy transpirable que puede disponer también de un soporte lumbar orientable y apoyabrazos regulables. El modelo de dirección se completa con reposa-cabeza acolchado coordinado con el acabado del asiento.

No Name Executive - Task



NO NAME DIREZIONALE EXECUTIVE

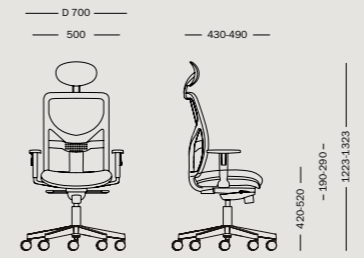

NO NAME OPERATIVA TASK

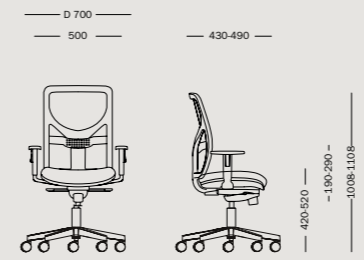



TEAM W

Sergio Bellin 2002

IT

Team W garantisce un solido sostegno ergonomico, grazie alla seduta con sistema anti-shock e meccanismo sincronizzato in cinque posizioni per la regolazione dell'angolo d'inclinazione tra sedile e schienale. La struttura interna in legno, che caratterizza il modello, assicura una resistenza altamente performante. Lo schienale è dotato di meccanismo Up&Down per la variazione dell'altezza. L'alto livello di comfort è completato dal sostegno lombare appositamente disegnato.

EN

The reassurance of professional expertise. With its antishock system seat and a synchronised mechanism for adjusting the seat and backrest angle into five different positions, Team W provides firm, ergonomic support. This model's distinctive internal wooden frame ensures high-performing strength. The backrest has a height adjusting Up&Down mechanism. A specially designed lumbar support completes this chair's high standard of comfort.

DE

Team W liefert ergonomische Stütze mit dem Antishock-Sitzsystem und Synchronverstellung der Neigung von Sitz und Rückenlehne auf fünf Positionen. Die charakteristische Innenstruktur aus Holz bei diesem Modell garantiert eine leistungsstarke, hohe Festigkeit. Die Rückenlehne ist mit einem Mechanismus Up&Down zur Verstellung der Höhe ausgestattet. Der hochwertige Komfort wird durch eine speziell entworfene Lendenstütze komplettiert.

FR

Un savoir-faire à toute épreuve. Team W garantit un solide soutien ergonomique, grâce à l'assise avec système antichoc et au mécanisme synchronisé à cinq positions pour le réglage de l'angle d'inclinaison entre l'assise et le dossier. La structure interne en bois qui caractérise le modèle assure une résistance très performante. Le dossier est muni du mécanisme Up&Down pour le réglage de la hauteur. Le haut niveau de confort est complété par le soutien lombaire spécialement dessiné.

ES

La seguridad de la mejor profesionalidad. Team W garantiza un sólido soporte ergonómico, gracias al asiento con sistema anti-shock y mecanismo sincronizado en cinco posiciones para la regulación del ángulo de inclinación entre asiento y respaldo. La estructura interna de madera caracteriza el modelo y asegura una resistencia de altas prestaciones. El respaldo dispone de mecanismo Up&Down para modificar la altura. El elevado nivel de comodidad se completa con el soporte lumbar diseñado específicamente.





TEAM W OPERATIVA TASK

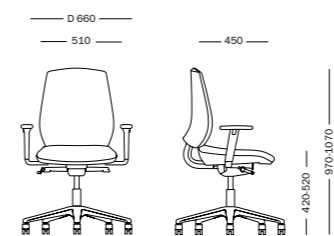



PASSE-PARTOUT

Sergio Bellin 2006

IT

Passe-partout è la collezione di sedute che risponde a tutte le esigenze di comfort ed estetica, per spazi di varia tipologia. Un elemento d'arredo adattabile e personalizzabile in una vasta gamma di rivestimenti pregiati. Passe-partout è disponibile nelle versioni visitatore su slitta e meeting.

EN

Passe-partout is a collection of seats that meets all comfort and styling requirements, for all sorts of settings. This adaptable piece of furniture can be customised with a broad range of fine upholsteries. Passe-partout is available in the sled-base visitor and meeting versions.

DE

Passe-partout ist eine Kollektion von Stühlen für die verschiedensten Räume, die allen Anforderungen an Komfort und Ästhetik entspricht. Ein anpassungsfähiges und individuell gestaltbares Einrichtungselement mit einer reichhaltigen Auswahl hochwertiger Bezugsmaterialien. Passe-partout ist in den Ausführungen als Besucherstuhl auf Kufen und als Konferenzstuhl verfügbar.

FR

Passe-partout est une collection de fauteuils qui répond à toutes les exigences en termes de confort et d'esthétique, pour s'adapter à différents types d'espace. Un objet de mobilier qui offre de multiples possibilités de personnalisation, grâce à une vaste gamme de revêtements de qualité. Passe-partout est disponible dans les modèles d'accueil avec pied luge et de réunion.

ES

Passe-partout es la colección de asientos que responde a todas las necesidades de confort y estética, para espacios de varios tipos. Un elemento de mobiliario que es posible adaptar y personalizar en una amplia gama de revestimientos de calidad. Passe-partout se encuentra disponible en las versiones confidente sobre trineo y reuniones.



—
Passe-Partout Visitor

—
Passe-Partout Meeting - Visitor

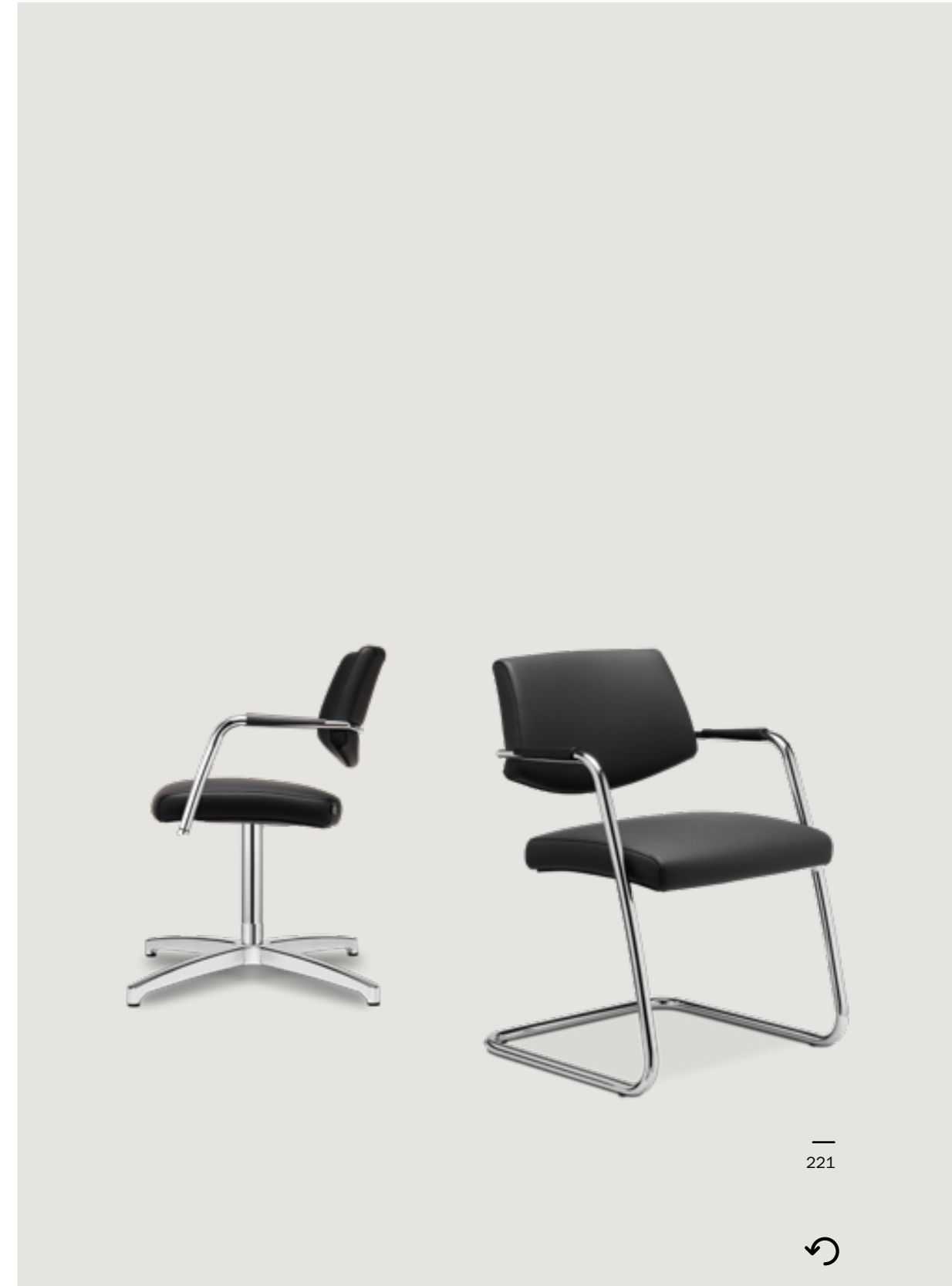

Passe-Partout Meeting - Visitor



PASSE-PARTOUT MEETING

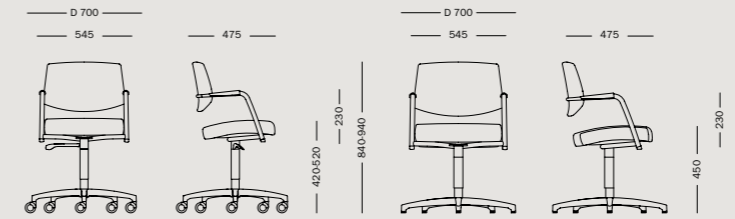
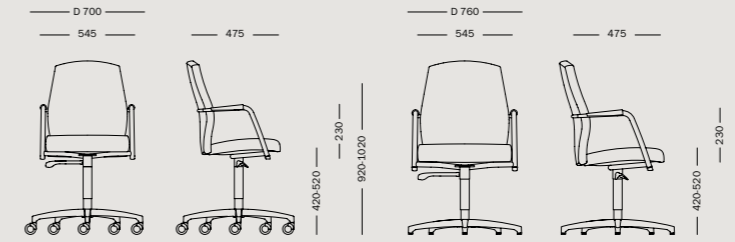

PASSE-PARTOUT VISITATORE VISITOR

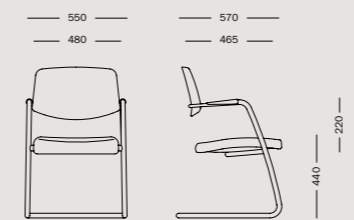
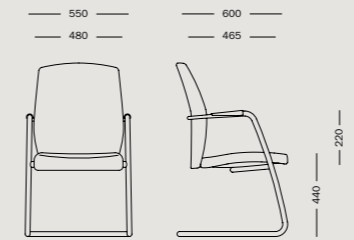



PK

Sergio Bellin 2007

IT

PK è la collezione di sedie dall'estetica essenziale, perfettamente adattabile ad ambienti di ogni stile. La struttura minimale, con il caratteristico telaio in tubo d'acciaio con braccioli integrati, è disponibile in finitura nero opaco, grigio chiaro o cromato. Lo schienale con il suo meccanismo flessibile si adatta alle esigenze posturali dell'utente. Schienale e sedile in rete garantiscono massima traspirabilità. Disponibile anche con seduta super comfort con anima in gomma flessibile, rivestita in una vasta gamma di tessuti.

EN

PK is a collection of chairs with a striking yet simple styling, making them perfectly suitable for all decorative styles. The minimalist structure, with its characteristic tubular steel frame with incorporated armrests, is available in matt black, light grey or chrome finish. Thanks to its flexible mechanism, the seat back adapts to the user's various postures. The mesh back and seat make for guaranteed breathability. Available also with super comfort seat upholstered with a broad range of fabrics.

DE

PK ist eine Kollektion von Stühlen von schlichtem Aussehen, perfekt für Räume der unterschiedlichsten Stilarten geeignet. Die minimalistische Struktur mit dem charakteristischen Gestell in der Form eines Stahlwürfels mit integrierten Armlehnen ist in mattschwarzer, hellgrauer oder verchromter Ausführung erhältlich. Die Rückenlehne mit ihrem flexiblen Mechanismus passt sich an die Haltungsbedürfnisse des Benützers an. Die Rückenlehne und die Sitzfläche aus Netzstoff gewährleistet eine maximale Atmungsaktivität. PK kann mit einer Superkomfort-Sitzfläche aus flexiblem Gummi ausgestattet werden, für die eine breite Palette von Geweben für den Bezug zur Verfügung steht.

FR

PK est la collection à l'esthétique sobre, parfaitement qui s'adapte à tous les styles d'espaces. La structure minimaliste, avec son châssis caractéristique en tube d'acier avec accoudoirs intégrés, est disponible dans les finitions noir mat, gris clair ou chromé. Grâce à son mécanisme flexible, le dossier s'adapte aux exigences posturales de l'utilisateur. Le dossier et l'assise en résille garantissent une respirabilité optimale. Disponible avec assise au confort renforcé, avec coeur en caoutchouc souple et revêtement textile disponible dans une vaste gamme de tissus.

ES

PK es la colección de estética esencial perfectamente adaptable a ambientes de diversos estilos. La estructura minimalista, con el característico bastidor en tubo de acero y apoyabrazos integrados, se encuentra disponible en acabado negro mate, gris claro o cromado. El respaldo, con su mecanismo flexible, se adapta a las necesidades posturales del usuario. Respaldo y asiento en red garantizan máxima transpirabilidad. Disponible con asiento superconfort en goma flexible revestida con una amplia gama de tejidos.

PK Meeting - Visitor



PK MEETING

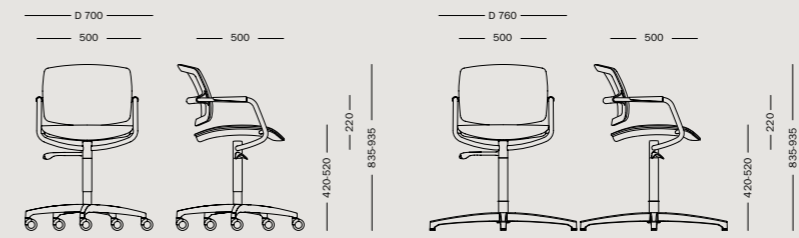

PK VISITATORE VISITOR

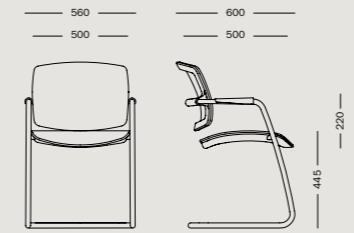



UNI

IT

Una seduta ideale in ogni ambiente, perfetta in aree di attesa e passaggio. Uni accoglie il visitatore con un comfort avvolgente e funzionale. Il telaio a slitta in tubo d'acciaio ad alta resistenza integra i braccioli coordinabili a schienale e sedile imbottiti, disponibili in differenti finiture tra tessuti e pelli. La collezione è proposta nelle due versioni, con schienale medio e schienale alto.

EN

An ideal seat in all spaces, perfect in waiting and transit areas. Uni welcomes visitors with cosy and functional comfort. The sled frame in high-strength tubular steel integrates the armrests which can be coordinated with upholstered seat and back, available in different fabric and leather finishes. The collection is available in two versions, with medium and tall back.

DE

Das ideale Sitzmöbel für jedes Ambiente, perfekt in Warte- und Durchgangsräumen. Uni nimmt den Besucher mit körpernahe, funktionalem Komfort auf. Das Kufengestell aus robustem Stahlrohr ergänzt die Armlehnen, abgestimmt auf Rückenlehne und Sitzfläche, beide gepolstert, erhältlich in diversen Ausführungen aus Stoff und Leder. Die Kollektion wird in zwei Varianten angeboten, mit mittelhoher oder hoher Rückenlehne.

FR

Un siège idéal dans n'importe quel environnement, parfait pour les zones d'attente et passage. Uni accueille le visiteur avec un confort enveloppant et fonctionnel. La structure à piètement luge en tube d'acier haute résistance intègre les accoudoirs qui peuvent être coordonnés au dossier et à l'assise rembourrée, disponibles en différentes finitions entre tissus et cuirs. La collection est proposée dans les deux versions, avec dossier moyen et dossier haut.

ES

Una silla ideal en cada ambiente, perfecta para las áreas de espera y de tránsito. Uni acoge al visitante con una comodidad envolvente y funcional. El bastidor de patín en tubo de acero de alta resistencia integra los apoyabrazos coordinados con el respaldo y asiento acolchados, disponibles en distintos acabados de tela y piel. La colección se presenta en dos versiones, con respaldo mediano y alto.

—
Uni Visitor



UNI VISITATORE VISITOR
—

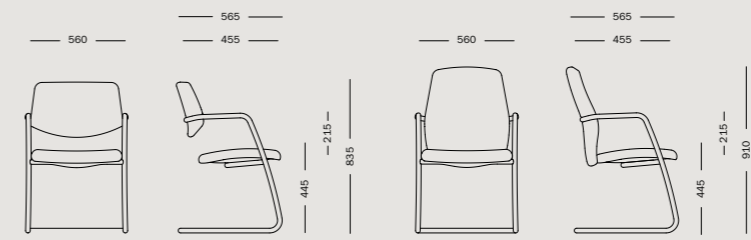



UNIMESH

IT

Progettata per collettività e ambienti di lavoro, caratterizzata da linee e volumi estremamente leggeri, Unimesh è la seduta ideale per l'accoglienza di sale riunioni e aule dedicate alla formazione. La struttura a slitta in tubo d'acciaio ad alta resistenza con braccioli integrati sostiene lo schienale ergonomico rivestito in rete altamente traspirante e il sedile imbottito indeformabile con tecnologia Comfort-Air.

EN

Designed for public and work environments and featuring extremely lightweight volumes and lines, Unimesh is the ideal seat for guests in meeting rooms and training rooms. The sled structure in high-strength tubular steel with integrated armrests supports the ergonomic back covered in highly breathable mesh and the shape-retaining padded seat with Comfort-Air technology.

DE

Unimesh, konzipiert für Gemeinschafts- und Arbeitsräume, ist dank äußerst schwereloser Linien und Volumen eine ideale Lösung für Konferenzräume und Lehrsäle. Das Kufengestell aus robustem Stahlrohr mit integrierten Armlehnen stützt die ergonomische, mit hoch atmungsaktivem Netzstoff bezogene Rückenlehne und die formstabile, in der Technologie Comfort-Air gepolsterte Sitzfläche.

FR

Conçu pour les collectivités et les milieux de travail, caractérisé par des lignes et des volumes extrêmement légers, Unimesh est le siège idéal pour l'accueil dans les salles de réunion ou les salles consacrées à la formation. La structure à piètement luge en tube d'acier haute résistance avec accoudoirs intégrés soutient le dossier ergonomique revêtu en maille filet hautement respirant et l'assise rembourrée indéformable avec technologie Comfort-Air.

ES

Diseñada para comunidades y entornos de trabajo, se caracteriza por líneas y volúmenes muy ágiles: Unimesh es la silla ideal para recibir a las personas en las salas de reunión y en las aulas de formación. La estructura de patín en tubo de acero de alta resistencia con apoyabrazos integrados sostiene el respaldo ergonómico recubierto en malla altamente transpirable y asiento acolchado indeformable con tecnología Comfort-Air.

Unimesh Visitor



UNIMESH VISITATORE VISITOR

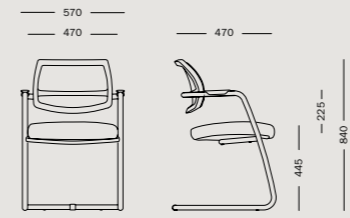

JOIN

D 20



IT

Stile disinvolto per ogni ambiente. Join, la sedia versatile che si adatta perfettamente sia ai contesti di attesa che alle sale meeting. Con un'elegante scocca in plastica, incarna il perfetto connubio tra estetica e funzionalità.

EN

Effortless style for every setting. Join, the versatile chair that seamlessly fits both visitor and meeting settings. With a sleek plastic shell, it embodies the perfect blend of aesthetics and functionality.

DE

Müheleose Eleganz für jede Umgebung. Join, der vielseitige Stuhl, der sich nahtlos in Besucher- und Besprechungsräume einfügt. Mit seiner eleganten Kunststoffschale verkörpert er die perfekte Mischung aus Ästhetik und Funktionalität.

FR

Un style informel pour tous les espaces. Join, le siège polyvalent qui s'adapte parfaitement aux espaces d'attente et aux salles de réunion. Avec son élégante coque en plastique, elle est la synthèse parfaite de l'esthétique et de la fonctionnalité.

ES

Estilo informal para cualquier entorno. Join, la silla versátil que encaja a la perfección tanto en zonas de espera como en salas de reunión. Con un elegante monocasco de plástico, representa la combinación perfecta de estética y funcionalidad.





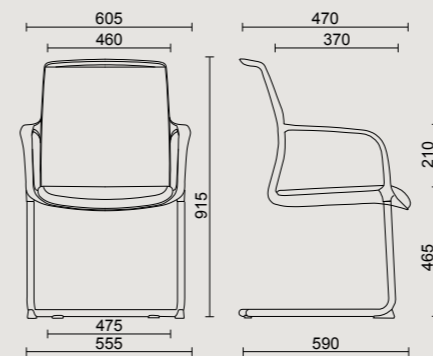

Visitor Chair

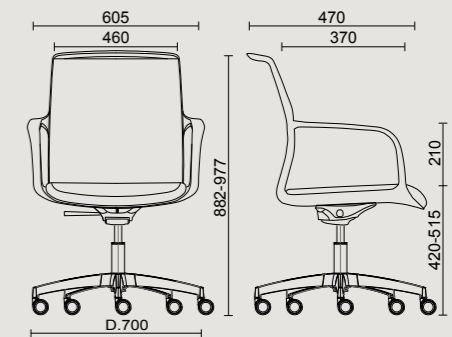

Meeting Chair 5-stars

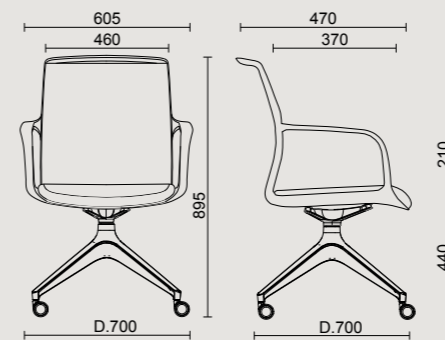

Meeting Chair 4-stars

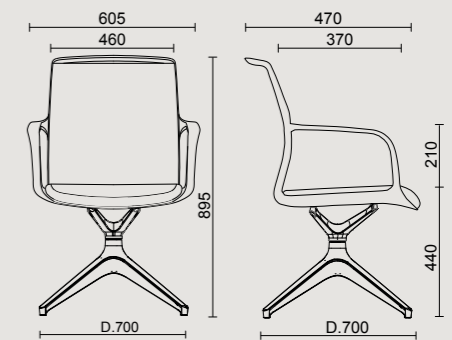

Meeting Chair 4-stars





SOUL

IT

Soul è la seduta dal design distintivo e contemporaneo, ideale per sale meeting o postazioni operative dall'estetica molto curata. Il telaio monoscocca in poliammide ad alta resistenza, con o senza braccioli integrati, è dotato di meccanismo oscillante autoregolante per un comfort sicuro e prolungato. Lo schienale imbottito sagomato è caratterizzato da un elegante motivo millerighe (Soul Tecno), disponibile in diverse cromie. La struttura è personalizzabile in finitura nera o grigio chiaro. La versione Soul Air è dotata di rete traspirante.

EN

Soul is a seat with a distinctive, contemporary design, making it ideal for meeting rooms or operational workstations with impeccable styling. The monoblock frame in high-resistance polyamide, with or without incorporated armrests, is fitted with a self-adjusting swinging mechanism for secure long-term comfort. The shaped padded back stands out for its elegant striped pattern (Soul Tecno), which is available in multiple colours. The structure can be customised in black or light grey finish. The Soul Air version features a breathable mesh.

DE

Soul ist der Stuhl mit markantem modernem Design, der bestens für Konferenzräume oder Arbeitsplätze mit sorgfältiger ästhetischer Gestaltung geeignet ist. Das Sitzschalengestell aus hoch widerstandsfähigem Polyamid, mit oder ohne integrierten Armlehnen, ist für den sicheren und dauerhaften Komfort mit einem selbstregelnden wippenden Mechanismus ausgestattet. Die geformte gepolsterte Rückenlehne ist durch ein elegantes Streifenmotiv (Soul Tecno) gekennzeichnet, das in verschiedenen Farbtönen verfügbar ist. Das Gestell ist in schwarzer oder hellgrauer Ausführung individuell wählbar. Die Ausführung Soul Air ist mit einem atmungsaktiven Netzstoff ausgestattet.

FR

Soul est un fauteuil au design caractéristique et contemporain, idéal pour les salles de réunion ou pour les postes de bureau à l'esthétique très soignée. Le châssis monocoque en polyamide haute résistance, avec ou sans accoudoirs intégrés, est doté d'un mécanisme oscillant autobloquant pour un confort sûr et prolongé. Le dossier rembourré modelé est caractérisé par un élégant motif à rayures (Soul Tecno) et disponible en différents coloris. La structure est personnalisable en différentes finitions (noir ou gris clair). La version Soul Air est dotée d'une résille transparente.

ES

Soul es el asiento de diseño diferencial y contemporáneo, ideal para salas de reuniones o zonas operativas de estética muy cuidada. El bastidor de una única pieza en poliamida de alta resistencia, con o sin apoyabrazos integrados, dispone de mecanismo oscilante con autorregulación, para un confort seguro y prolongado. El respaldo mullido perfilado se caracteriza por un elegante tema millrayas (Soul Tecno), disponible en diversos colores. La estructura se puede personalizar en acabado negro o gris claro. La versión Soul Air dispone de red transpirable.



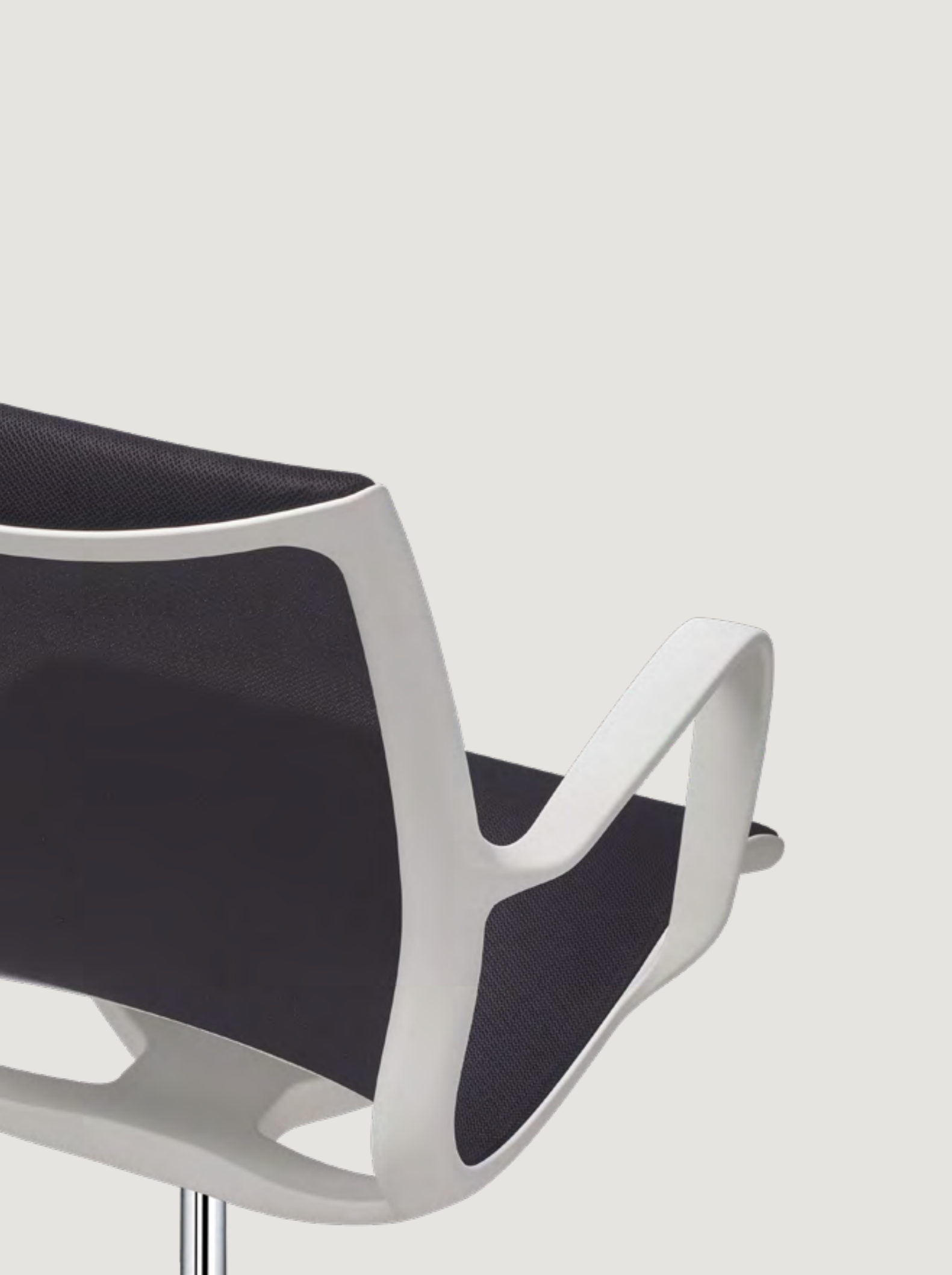

—
Soul Air Meeting

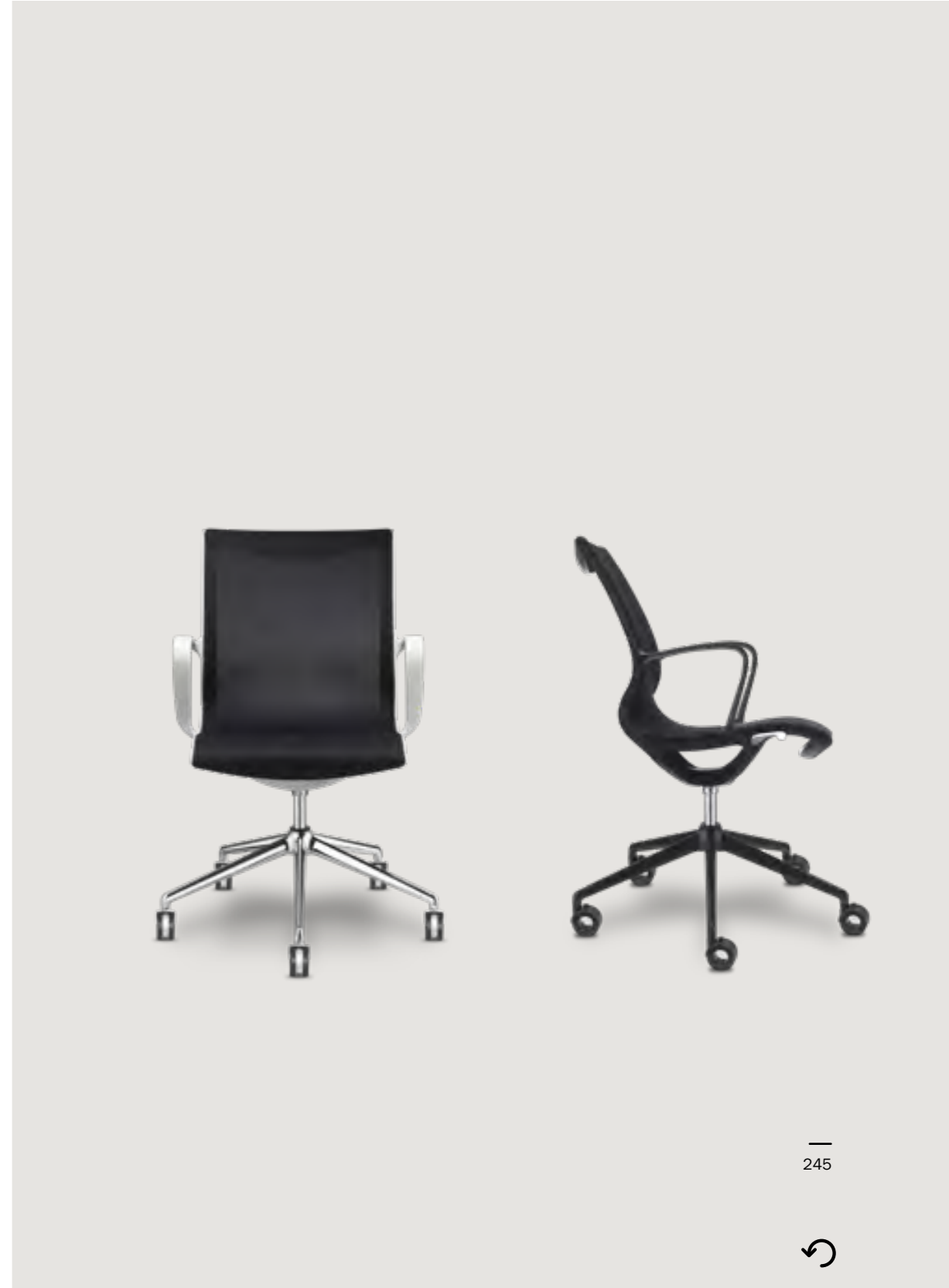

Soul Tecno Meeting



SOUL MEETING

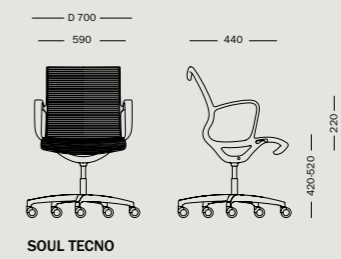
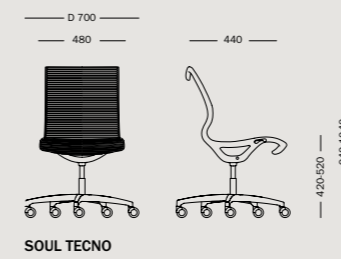
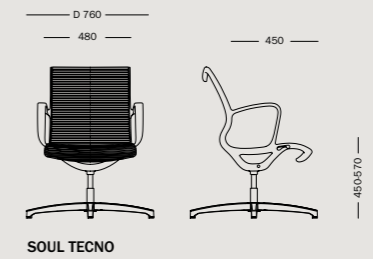
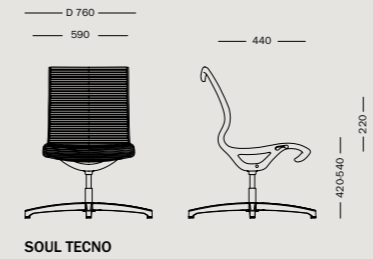
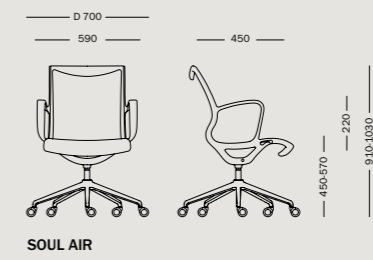
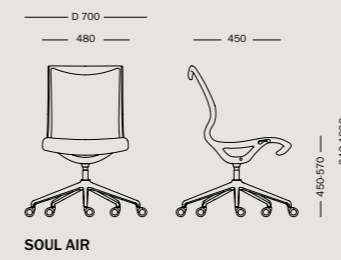
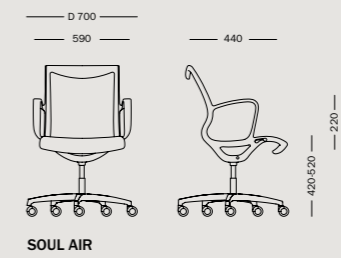
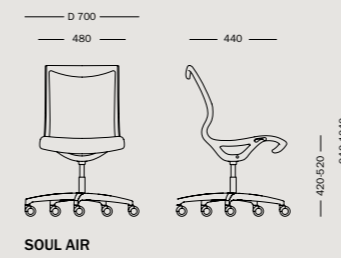
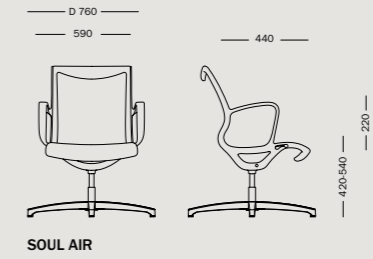
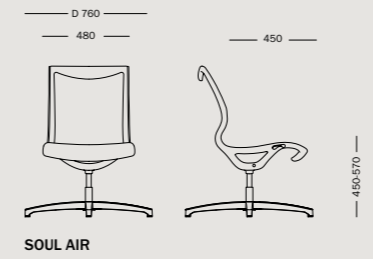
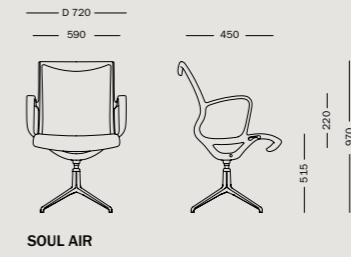
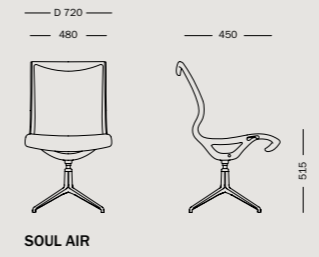



LOTUS

IT

Lotus è la monoscocca in plastica con braccioli integrati e sedile tappezzato. Leggera e avvolgente nelle forme, è disponibile in diversi colori e con due basi: 5 razze con ruote o trespolo. Lo schienale è caratterizzato da un motivo originale realizzato con piccoli fori che offrono un'alta traspirabilità e donano particolare leggerezza al design.

EN

Lotus is a plastic single-shell frame with integrated armrests and an upholstered seat. Lightweight and all-embracing, it is available in various colours and in a choice of two bases: a 5-spoke base with castors or a trestle base. The backrest features an original pattern created with small perforations that offer a high level of breathability and add special lightness to the design.

DE

Lotus ist der einschalige Stuhl aus Kunststoff mit integrierten Armlehnen und gepolsterter Sitzfläche. Mit seinen leichten und bequemen Formen ist er in verschiedenen Farben und mit zwei Untergestellen erhältlich: 5-armiges Fußkreuz mit Rädern oder Sternfuß. Die Rückenlehne zeichnet sich durch ein originelles Muster mit kleinen Blumen aus, die große Atmungsaktivität bieten und dem Design eine besondere Leichte verleihen.

FR

Lotus est la monocoque en plastique avec des accoudoirs intégrés et une assise rembourrée. Aux formes légères et enveloppantes, il est disponible en différentes couleurs et avec deux bases : 5 rayons avec roues ou piètement central. Le dossier se caractérise par un motif original fait de petits trous offrant une grande respirabilité et une légèreté particulière au design.

ES

Lotus es la silla de una sola pieza de plástico con brazos integrados y asiento tapizado. Ligera y envolvente en sus formas, está disponible en diferentes colores y con dos bases. 5 radios con ruedas o trípode. El respaldo se caracteriza por un motivo original realizado con pequeños agujeros que ofrecen una elevada transpirabilidad y otorgan una ligereza especial al diseño.



LOTUS MEETING

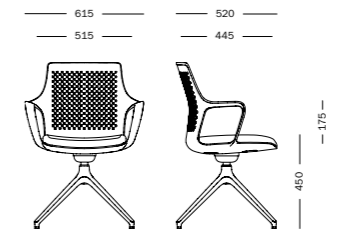
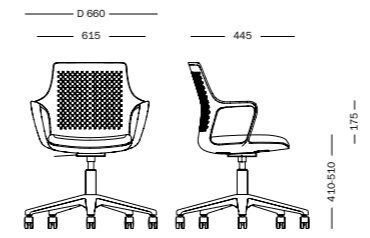



MILOS LIFE

—
Dorigo Design 2017



—
IT

Milos Life è la seduta dall'estrema leggerezza estetica, con un sedile monoscocca dalla linea sottile e flessibile, sostenuto da un solido e indeformabile telaio interno in acciaio.

—
EN

Milos Life is a seating with extreme aesthetic lightness, with a single-shell seat with a slim and flexible line, supported by a solid and non-deformable inner frame in steel.

—
DE

Milos Life ist ein Sitzmöbel von extrem schwereloser Ästhetik, mit einteiliger Sitzschale in schlanken, biegsamen Linien, getragen von einem soliden, formstabilen Innenrahmen aus Stahl.

—
FR

Milos Life est le siège qui associe l'extrême légèreté de son design à la ligne fine et souple de son assise monocoque, soutenue par un cadre interne en acier solide et indéformable.

—
ES

Milos Life es un modelo de sorprendente ligereza estética, con un asiento monocasco de línea delgada y flexible, sostenido por un bastidor interno de acero sólido e indeformable.

—
PREMI AWARDS

Good Design 2021









MILOS LIFE MEETING

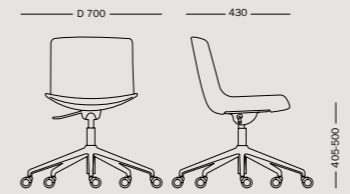
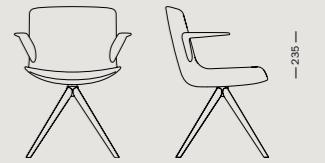
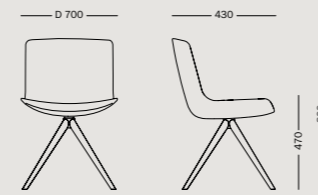

MILOS LIFE SGABELLO STOOL

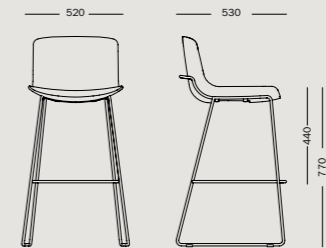
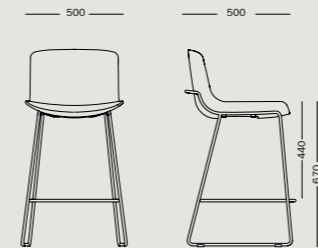



MILOS ELLE

Dorigo Design 2017

IT

Milos Elle propone l'estetica del modello Milos Life. La scocca in plastica è il risultato di una ricerca progettuale avanzata, che ha permesso un risultato estetico di estrema leggerezza, mantenendo massima resistenza nella seduta.

EN

Milos Elle offers the aesthetic of the Milos Life model. The plastic shell is the result of advanced design research, which has led to an aesthetic result of extreme lightness, maintaining maximum resistance in the seat.

DE

Milos Elle entspricht in der Ästhetik dem Modell Milos Life, jedoch mit einer strukturellen Variante, die ihren Fokus in besonders leistungsstarken Materialien hat. Die Sitzschale aus Kunststoff ist unglaublich zart, Ergebnis einer modernen konstruktiven Entwicklung, die eine ungemein schwerelose Ästhetik bei einer gleichzeitig höchsten Festigkeit im Gebrauch ermöglicht.

FR

Milos Elle propose l'esthétique du modèle Milos Life, avec une variante au niveau de la structure, fruit de la recherche des matériaux les plus performants. La coque en plastique est extrêmement fine, c'est le résultat d'une étude sur une technique de pointe, qui a permis un résultat esthétique d'une légèreté extrême, tout en conservant une résistance à toute épreuve au niveau de l'assise.

ES

Milos Elle propone el aspecto estético del modelo Milos Life, con una variante estructural focalizada en el estudio de las prestaciones de los materiales. El espesor de la carcasa de plástico es increíblemente fino, resultado de un estudio de proyecto avanzado, que ha logrado un resultado estético de gran ligereza, manteniendo la máxima resistencia del asiento.







MILOS ELLE VISITATORE VISITOR

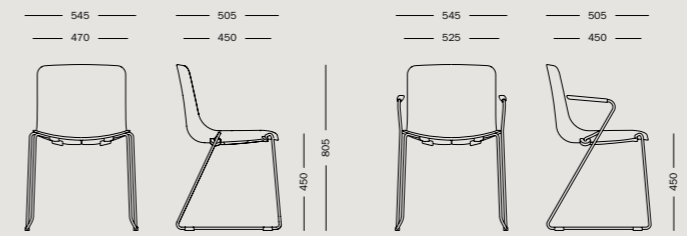

MILOS ELLE 4 GAMBE 4-LEGS

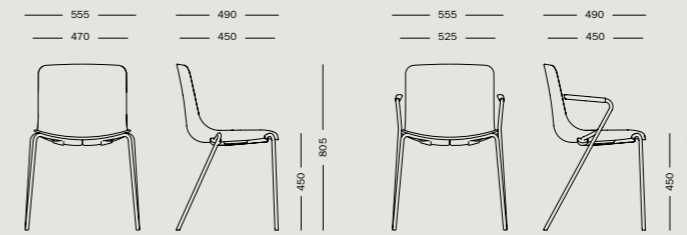

MILOS ELLE SGABELLO STOOL

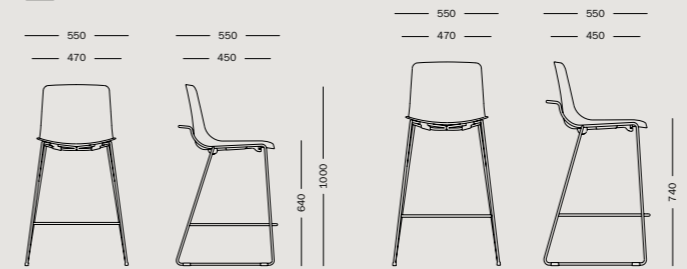



MILOS TAILOR

Dorigo Design 2022



IT

Milos Tailor è una seduta dal profilo in acciaio verniciato, rivestito in tessuto autoportante sfoderabile, adatta sia ad ambienti indoor che outdoor. Il rivestimento di Milos Tailor può essere facilmente rimosso grazie a cerniere, permettendo di sostituire o lavare il tessuto, allungando così il ciclo di vita del prodotto. Giocando con un'ampia selezione di colori e rivestimenti intercambiabili, Milos Tailor è una soluzione altamente personalizzabile e versatile, che si adatta con facilità a diverse tipologie di ambienti.

EN

Milos Tailor is a seat with a painted steel profile, upholstered by removable supporting fabric, suitable for both indoor and outdoor environments. The upholstery of Milos Tailor can be easily removed thanks to practical zips. This allows the fabric to be replaced or cleaned, extending the product's life cycle. Playing with a wide selection of colours and upholsteries, Milos Tailor is a highly customisable and versatile solution that easily fit in different types of environments.

DE

Milos Tailor ist ein Sitz mit lackiertem Stahlprofil, der mit abnehmbarem, selbsttragendem Stoff bezogen ist und sich sowohl für den Innen- als auch den Außenbereich eignet. Der Bezug von Milos Tailor lässt sich dank praktischer Reißverschlüsse leicht abnehmen, so dass der Stoff ausgetauscht oder gewaschen werden kann, was den Lebenszyklus des Produkts verlängert. Mit einer großen Auswahl an austauschbaren Farben und Bezügen ist Milos Tailor eine äußerst anpassungsfähige und vielseitige Lösung, die sich leicht an verschiedene Umgebungen anpassen lässt.

FR

Milos Tailor est un siège avec profil en acier peint, recouvert d'un tissu autoportant amovible, adapté aux environnements intérieurs et extérieurs. La housse de Milos Tailor peut être facilement déhoussable grâce à la fermeture à glissière, qui permet de remplacer le tissu ou de le laver, prolongeant ainsi le cycle de vie du produit. Jouant sur un large choix de couleurs et de garnitures interchangeables, Milos Tailor est une solution hautement personnalisable et polyvalente, qui s'adapte facilement à différents types d'environnements.

ES

Milos Tailor es un asiento con perfil de acero pintado, recubierto de tela desenfundable autoportante, apto tanto para ambientes interiores como exteriores. La funda de Milos Tailor se puede retirar fácilmente gracias a unas cómodas cremalleras, lo que permite sustituir el tejido o lavarlo, alargando así el ciclo de vida del producto. Con una amplia selección de colores y tapizados intercambiables, Milos Tailor es una solución muy personalizable y versátil, que se adapta fácilmente a diferentes tipos de ambientes.





—
Milos Tailor 4-legs

—
Milos Tailor 4-legs





MILOS TAILOR 4 GAMBE 4-LEGS

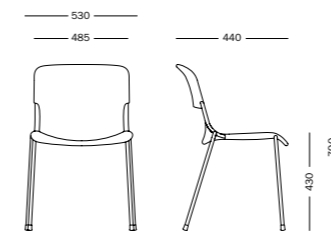

MILOS TAILOR SGABELLO STOOL

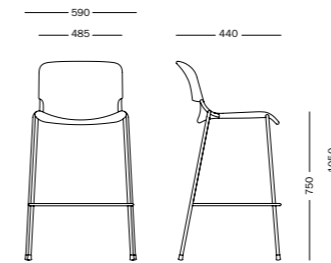



MILOS SHELL

IT

Milos Shell rappresenta la naturale evoluzione di Milos Life e presenta una monoscocca in polipropilene, completamente imbottita.

Confortevole ed elegante, Milos Shell diventa una soluzione flessibile per ogni esigenza.

Il comfort dato dal cuscino imbottito e la varietà di basi disponibili la rendono perfetta per qualsiasi spazio, dalle sale riunioni alle abitazioni private.

EN

Milos Shell represents the natural evolution of Milos Life and features a single-shell polypropylene frame, fully upholstered.

Comfortable and elegant, Milos Shell becomes a flexible solution for every need.

The comfort provided by the padded cushion and the variety of available bases make it perfect for any space, from meeting rooms to private homes.

DE

Milos Shell stellt die natürliche Weiterentwicklung von Milos Life dar und verfügt über eine Monoschale aus Polypropylen, die vollständig gepolstert ist.

Komfortabel und elegant wird Milos Shell zu einer flexiblen Lösung für jedes Bedürfnis.

Der Komfort des gepolsterten Kissens und die Vielzahl an verfügbaren Basen machen es perfekt für jeden Raum, von Besprechungsräumen bis hin zu privaten Haushalten.

FR

Milos Shell représente l'évolution naturelle de Milos Life et présente une coque unique en polypropylène, entièrement rembourrée.

Confortable et élégante, Milos Shell devient une solution flexible pour tous les besoins.

Le confort apporté par le coussin rembourré et la variété des bases disponibles en font la solution idéale pour tous les espaces, des salles de réunion aux maisons privées.

ES

Milos Shell representa la evolución natural de Milos Life y presenta una carcasa monobloque de polipropileno, completamente acolchonada.

Cómoda y elegante, Milos Shell se convierte en una solución flexible para cualquier necesidad.

La comodidad proporcionada por el cojín acolchado y la variedad de bases disponibles la convierten en la opción perfecta para cualquier espacio, desde salas de reuniones hasta viviendas privadas.







MILOS SHELL 4-LEGS

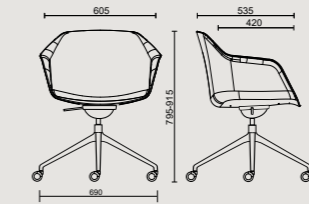
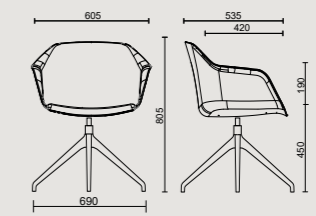
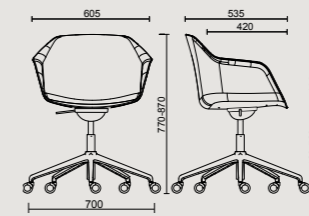
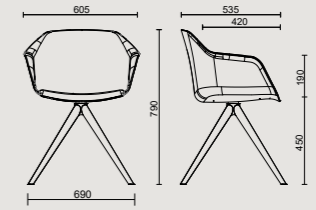
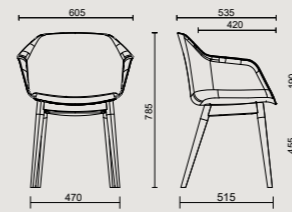



MAIL

IT

Definita da un design essenziale, che ne sottolinea leggerezza e volumi sottili, Mail è la seduta multifunzionale, dedicata alla collettività e agli spazi condivisi. Disponibile con e senza braccioli, propone uno schienale altamente traspirante, caratterizzato da trame geometriche, e un sedile imbottito personalizzabile in diverse finiture. Può essere dotata di tavoletta-scrittoio e cestino porta-riviste. La versione senza braccioli è impilabile orizzontalmente.

EN

Defined by an understated design which underscores its light weight and slim volumes, Mail is a multitasking seat, designed for public and shared spaces. Available with and without armrests, it offers a highly breathable back featuring geometric weaves and a padded seat which can be personalised with different finishes. It can also be fitted with a writing tablet and magazine rack. The version without armrests can be stacked horizontally.

DE

Ein minimalistisches Design unterstreicht Leichtigkeit und schlanke Volumen von Mail, vielseitiges Sitzmöbel für Gemeinschafts- und Aufenthaltsräume. Erhältlich mit oder ohne Armlehnen, ausgeführt mit einer hoch atmungsaktiven Rückenlehne mit charakteristischer, geometrischer Musterung und einer gepolsterten Sitzfläche in diversen Ausführungen nach Wahl. Kann auch mit Schreibplatte und Zeitschriftenablage ausgestattet werden. Die Variante ohne Armlehnen ist horizontal stapelbar.

FR

Praticité. Défini par un design essentiel qui en souligne la légèreté et la finesse des volumes, Mail est un siège multifonctions pour les collectivités et les espaces partagés. Disponible avec et sans accoudoirs, il propose un dossier hautement respirant, caractérisé par des trames géométriques, et une assise rembourrée personnalisable en différentes finitions. Il peut être équipé d'une tablette-écritoire et d'une corbeille porte-revues. La version sans accoudoirs est empilable horizontalement.

ES

Definida por un diseño esencial, que remarca la ligereza y los volúmenes finos, Mail es el asiento multifunción dedicado a la colectividad y a los espacios compartidos. Disponible con y sin apoyabrazos, propone un respaldo altamente transpirable, caracterizado por tramas geométricas y un asiento acolchado personalizable en distintos acabados. Puede equiparse con pala para escritura y bandeja revistero. La versión sin apoyabrazos puede apilarse horizontalmente.



MAIL VISITATORE VISITOR

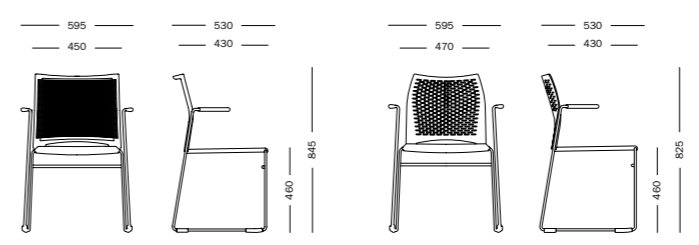



MIKADO

IT

Dedicata a spazi collettivi come sale riunioni, aree formative, aule conferenze, spazi d'attesa ed esterni, Mikado è la seduta impilabile con schienale e sedile in polipropilene stampato a iniezione e resistente ai raggi UV, e telaio in acciaio ad alta resistenza, in finitura cromata. La collezione dalle semplici linee incrociate, può essere personalizzata con diversi elementi come tavoletta-scrittoio, braccioli, sedile ribaltabile, ruote, agganci laterali e carrello.

EN

Multifunction design. Designed for group spaces such as meeting rooms, training areas, conference halls, waiting areas and outdoors, Mikado is the stackable seat with back and seat in injection-moulded UV-resistant polypropylene and high-strength steel frame, in chromed finish. The collection with simple crossed lines can be personalised with different elements such as the writing tablet, armrests, tip-up seat, Casters, side hooks and trolley.

DE

Mikado wurde für kollektive Räume wie Sitzungszimmer, Lehrsäle, Konferenzsäle, Wartebereiche und Räume im Freien konzipiert: stapelbar, Rückenlehne und Sitz aus Polypropylen in Spritzgusstechnik, beständig gegen UV-Strahlen, Farbe Chrom. Das Möbel, schlicht in den gekreuzten Linien, kann durch verschiedene Elemente ergänzt werden, wie Schreibpult, Armlehnen, Klappsitz, Rollen, seitliche Einhängung und Fahrgestell.

FR

Dédié aux espaces collectifs comme les salles de réunion, les salles de formation ou de conférence, les zones d'attente et les espaces extérieurs, Mikado est une chaise empilable avec dossier et assise en polypropylène moulé par injection et résistant aux rayons UV, et une structure en acier haute résistance, dans la finition chromée. La collection aux simples lignes croisées peut être personnalisée avec différents éléments comme la tablette-écritoire, les accoudoirs, l'assise basculante, les roulettes, les fixations latérales et le chariot.

ES

Dedicada a los espacios colectivos como las salas de reunión, áreas de formación, salas de conferencias, espacios de espera y exteriores, Mikado es la silla apilable con respaldo y asiento en polipropileno estampado por inyección y resistente a los rayos UV, con bastidor de acero de alta resistencia en acabado cromado. La colección de simples líneas cruzadas puede personalizarse con distintos elementos como la pala para escritura, los apoyabrazos, el asiento abatible, las ruedas, los enganches laterales y el carro.



MIKADO 4 GAMBE 4-LEGS

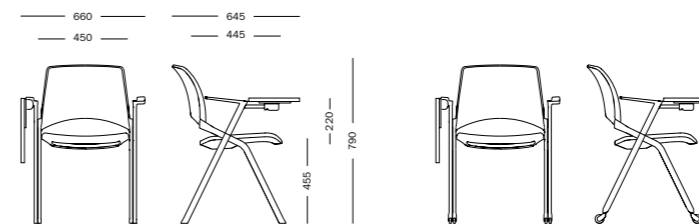
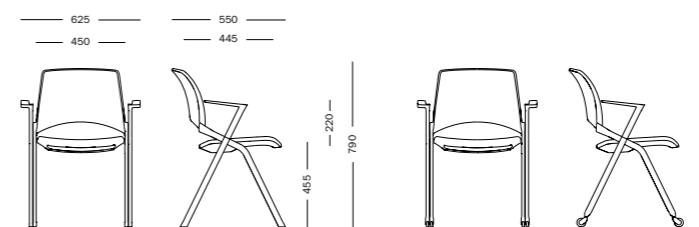
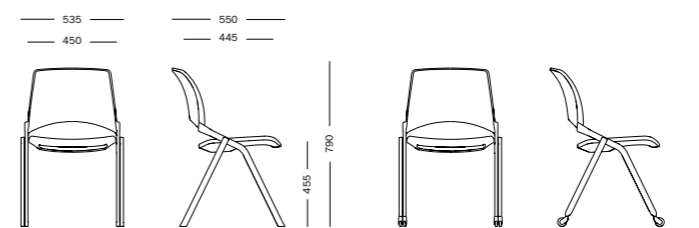



GREEN'S

Baldanzi & Novelli 2008



IT

Green'S è una seduta unica nel mondo della collettività e delle aree di attesa. Completamente riciclabile, è realizzata con materiale plastico ad alta resistenza. Un prodotto che segna un traguardo eccezionale nella produzione del settore. La struttura dello schienale, realizzata in un corpo unico, è dotata di sistema brevettato Flex-system, per un comfort assolutamente inedito. Perfetta per aule formative, sale conferenze, spazi attesa e meeting. Perfettamente impilabile. È possibile applicare alla seduta i cuscini rivestiti in un'ampia gamma di tessuti.

EN

Green'S is a unique chair, truly one of a kind in the world of waiting rooms and communal areas. It is completely recyclable, since it is made of high resistance plastic. This product marks an exceptional milestone in this industry. The structure of the seat back, which is made of a single block, is fitted with the patented Flex-system, for absolutely unprecedented comfort. Perfect for training classrooms, conference halls, waiting and meeting areas. Perfectly stackable. Upholstered cushions can be applied to the seat, and these are available in a broad range of fabrics.

DE

Green'S ist in der Welt der Öffentlichkeit und der Wartebereiche ein einzigartiger Stuhl. Er ist zur Gänze wieder verwertbar und besteht aus einem hoch widerstandsfähigen Kunststoffmaterial. Ein Produkt, das einen außergewöhnlichen Erfolg in der Produktion der Branche kennzeichnet. Die Struktur der aus einem einzigen Stück hergestellten Rückenlehne ist für einen noch nie da gewesenen Komfort mit dem patentierten Flex-System ausgestattet. Geeignet für Schulungsräume, Warte- und Konferenzräume und perfekt stapelbar. Es ist möglich, dem Stuhl bezogene Polster hinzuzufügen, die in einer umfangreichen Farbauswahl erhältlich sind.

FR

Green'S est une chaise unique destinée aux collectivités et aux espaces d'accueil. Entièrement recyclable, elle est réalisée en un matériau plastique haute résistance. Un produit qui marque un tournant important dans le secteur. La structure du dossier, réalisé d'une seule pièce, est dotée d'un système breveté Flex-system qui assure un confort absolument inédit. Parfaitement empilable Green's est idéale pour les salles de formation ou de conférence, les espaces d'accueil et de réunion. Il existe des coussins à appliquer sur l'assise, disponibles dans une vaste gamme de tissus.

ES

Green'S es un asiento único en el mundo de la colectividad y de las áreas de espera. Completamente reciclable, se realiza con material plástico de alta resistencia. Se trata de un producto que representa un hito excepcional en la producción del sector. La estructura del respaldo, realizada en un cuerpo único, dispone de sistema patentado Flex-system, para un confort absolutamente inédito. Ideal para aulas de formación, salas de conferencias, de espera y de reuniones. Perfectamente apilable. Es posible aplicar al asiento los cojines revestidos en una amplia gama de tejidos.





Green'S 4-legs





GREEN'S 4 GAMBE 4-LEGS

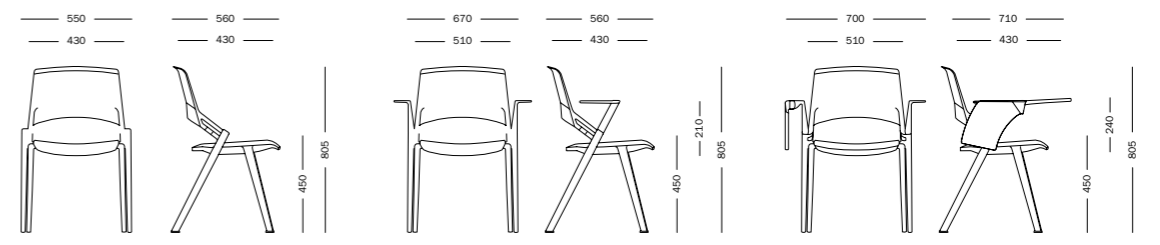



AMBER

IT

Amber è una sedia monoscocca in polipropilene, disponibile in sei colori vivaci che creano affascinanti geometrie di colore. La possibilità di scegliere tra quattro diverse basi la rende una seduta versatile e adatta ad ogni ambiente. Per rendere la sedia ancora più confortevole è possibile aggiungere un cuscino imbottito coordinato nell'ampia seduta.

EN

Amber is a single-shell polypropylene chair, available in six vibrant colors that create captivating color geometries. The option to choose from four different bases makes it a versatile seat suitable for any environment. To make the chair even more comfortable, a coordinated padded cushion can be added to the wide seat.

DE

Amber ist ein Stuhl aus Polypropylen in einer Monoschale, erhältlich in sechs lebendigen Farben, die faszinierende Farbgeometrien schaffen. Die Möglichkeit, zwischen vier verschiedenen Basen zu wählen, macht ihn zu einem vielseitigen Sitz, der für jede Umgebung geeignet ist. Um den Stuhl noch komfortabler zu machen, kann ein passendes gepolstertes Kissen auf dem breiten Sitz hinzugefügt werden.

FR

Amber est une chaise à coque unique en polypropylène, disponible en six couleurs vives qui créent de fascinantes géométries de couleurs. La possibilité de choisir parmi quatre bases différentes en fait un siège polyvalent et adapté à tous les environnements. Pour rendre la chaise encore plus confortable, un coussin rembourré coordonné peut être ajouté à l'assise large.

ES

Amber es una silla monobloque de polipropileno, disponible en seis colores vibrantes que crean fascinantes geometrías de color. La opción de elegir entre cuatro bases diferentes la convierte en una silla versátil y adecuada para cualquier entorno. Para hacer la silla aún más cómoda, se puede añadir un cojín acolchonado a medida en el amplio asiento.







AMBER 4-LEGS

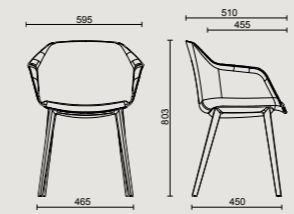

AMBER MEETING 5 STAR

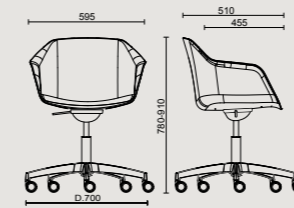

AMBER MEETING 4 STAR

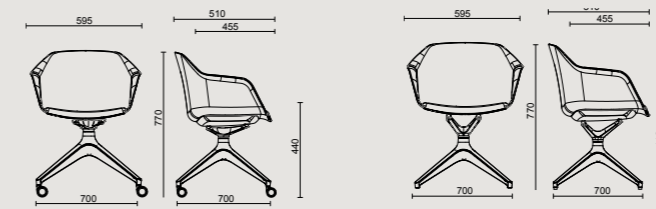



CELL128

Dorigo Design 2015

IT

Il sistema di sedute Cell128 è caratterizzato dall'originale schienale extra altezza, dedicato a discrezione e relax. Cell128 offre riservati istanti d'isolamento, preziosi per una pausa o un'estemporanea sessione lavorativa. Un elegante tavolino, con supporto e piano girevole, completa il comfort dell'arredo, personalizzabile anche con caricatore USB.

EN

The Cell128 seating system features the original extra-height back, designed for discretion and relaxation. Cell128 offers private moments of solitude, precious for a pause or an unexpected work session. An elegant coffee table, with rotating top and support, adds to the comfort of the decor, with possible customisation with USB charger.

DE

Das Sitzsystem Cell128, das in der originellen, extrahohen Rückenlehne das besondere Merkmal hat, sorgt für Diskretion und Entspannung. Cell128 ermöglicht Momente der Abgeschiedenheit, für eine kleine Pause oder improvisierte Arbeitssession. Ein elegantes Tischchen, mit Halterung und schwenkbarer Platte, macht den Einrichtungskomfort komplett; kann auch mit Ladegerät USB individuell ausgestattet werden.

FR

Les sièges Cell128 se distinguent par leur dossier original très haut, pour une grande discrétion et une détente totale. Avec Cell128, isolez-vous un instant, pour une pause ou pour une séance de travail impromptue. Une table élégante, avec support et plateau tournant, complète le confort du produit, que vous pourrez personnaliser avec un chargeur USB.

ES

El sistema de asientos Cell128 es caracterizado por el original respaldo de mayor altura, consagra la discreción y el descanso. Cell128 ofrece instantes de aislamiento reservados, preciosos para una pausa o una sesión de trabajo imprevista. Una mesa de centro elegante, con soporte y tablero giratorio, completa el bienestar de la decoración, puede personalizarse también con cargador USB.

PREMI AWARDS

Good Design 2020









CELL128 POLTRONA ARMCHAIR

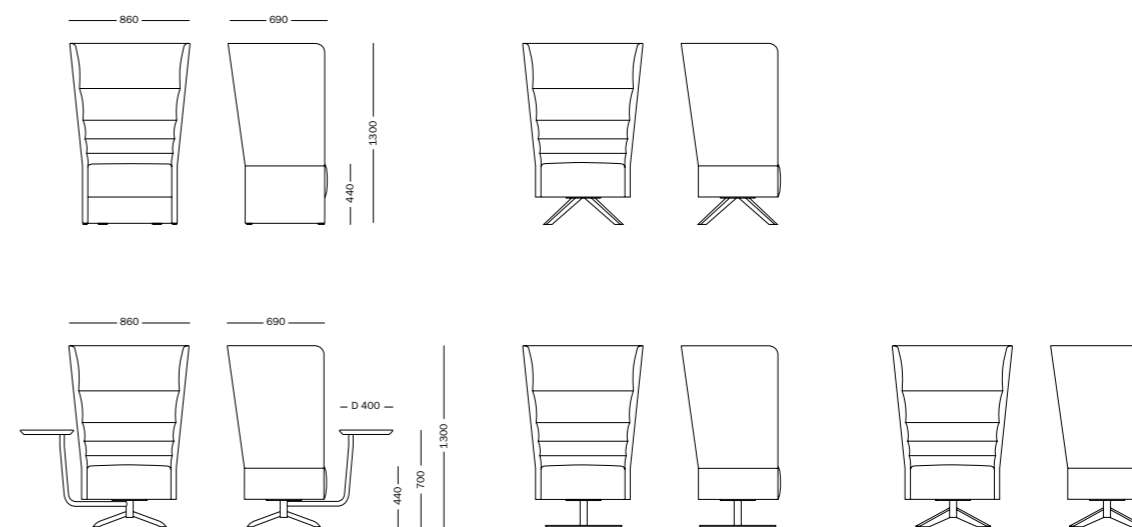

CELL128 DIVANO 2 POSTI 2-SEATER SOFA

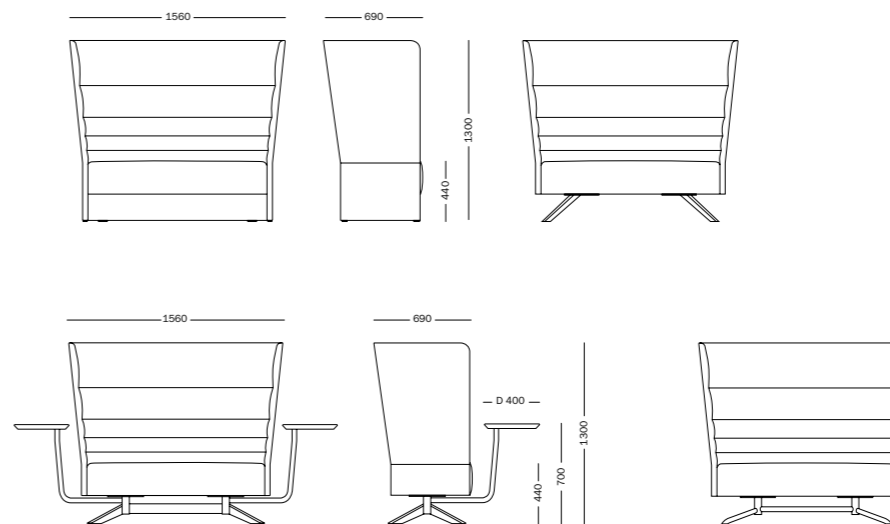



CELL SPACE

Dorigo Design 2023

IT

CellSpace è la soluzione innovativa per chi desidera il massimo comfort e la massima versatilità negli spazi condivisi. Pensato per essere da due o da quattro posti, CellSpace nasce dall'unione di due poltrone o di due divani Cell128, by Dorigo Design. L'aggiunta del pannello con tavolino integrato permette di creare il prodotto perfetto per aeroporti, uffici o qualsiasi ambiente aperto dove il bisogno di privacy si incontra con la dinamicità del lavoro moderno.

EN

CellSpace is an innovative solution for those who want maximum comfort and versatility in shared spaces. Designed to be a two- or four-seater, CellSpace is the result of the combination of two Cell128 armchairs or sofas, by Dorigo Design. The added panel with integrated coffee table creates the perfect product for airports, offices or any open environment where the need for privacy meets the dynamism of modern work.

DE

CellSpace ist die innovative Lösung für alle, die maximalen Komfort und Vielseitigkeit in gemeinsam genutzten Räumen wünschen. CellSpace kann als Zwei- oder Viersitzer konzipiert werden und ist das Ergebnis der Kombination von zwei Cell128 Sesseln oder Sofas von Dorigo Design. Die hinzugefügte Platte mit integriertem Couchtisch schafft das perfekte Produkt für Flughäfen, Büros oder jede offene Umgebung, in der das Bedürfnis nach Privatsphäre auf die Dynamik der modernen Arbeit trifft. Mechanismus und einem minimalistischeren Design gearbeitet.

FR

CellSpace est la solution innovante pour ceux qui veulent un maximum de confort et de polyvalence dans les espaces partagés. Conçu pour accueillir deux ou quatre personnes, CellSpace est le résultat de la combinaison de deux fauteuils ou canapés Cell128, de Dorigo Design. L'ajout d'un panneau avec une table basse intégrée crée le produit parfait pour les aéroports, les bureaux ou tout autre environnement ouvert où le besoin d'intimité rencontre le dynamisme du travail moderne.

ES

CellSpace es la solución innovadora para quienes desean el máximo confort y versatilidad en espacios compartidos. Diseñado para dos o cuatro personas, CellSpace nace de la unión de dos sillones o sofás Cell128, de Dorigo Design. La adición del panel con mesa de centro integrada crea el producto perfecto para aeropuertos, oficinas o cualquier entorno abierto donde la necesidad de privacidad se une al dinamismo del trabajo moderno. trabajado en la integración de los mecanismos y en un diseño más minimalista.







CELL SPACE

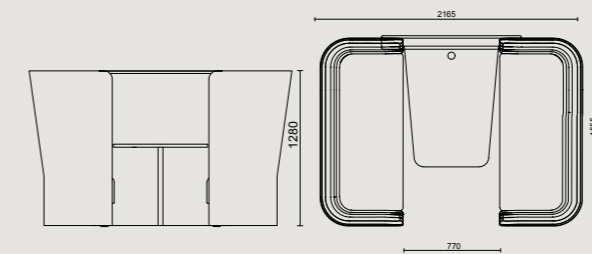
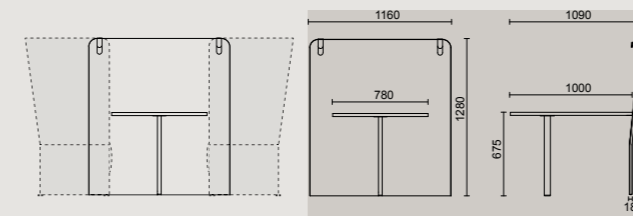
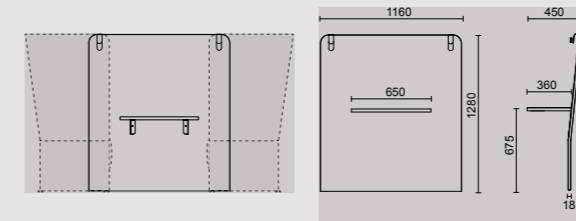
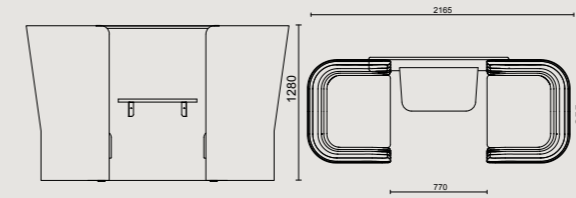



CELL72

Dorigo Design 2015

IT

Declinazione di Cell128, Cell72 è la collezione di poltrone e divani a due posti nella variante con schienale basso, pensata per rispondere a esigenze di apertura compositiva. Raffinato e funzionale, lo spazio delle sedute può essere completato dal tavolino con supporto girevole, agevolmente accostabile o escludibile. Disponibile in numerosi colori e finiture, è presentato con basi diverse, in finitura legno o acciaio.

EN

A version of Cell128, Cell72 is the collection of two-seater sofas and armchairs in the version with low back, designed to meet needs of open compositions. Sophisticated and functional, the seating space can be completed by the coffee table with rotating support, easily coordinated or stand alone. Available in many colours and finishes, it is presented with different bases in wood or steel finish.

DE

Cell72, eine Abwandlung von Cell128, ist eine Kollektion von Sesseln und zweisitzigen Sofas in der Variante mit niedriger Rückenlehne, die dem Bedürfnis nach kompositorischer Offenheit entspricht. Raffiniert und zweckmäßig, kann der Sitzbereich durch das Tischchen mit schwenkbarer Halterung ergänzt werden, das je nach Bedarf seine Stellung verändert. Erhältlich in zahlreichen Farben und Ausführungen, mit verschiedenen Untergestellen, in Holzdekor oder Stahl.

FR

Cell72, déclinaison de Cell128, est la collection de fauteuils et de canapés à deux places dans la version dossier bas, conçue pour répondre aux besoins des espaces ouverts. Raffiné et fonctionnel, l'espace consacré aux sièges peut accueillir également la table basse à support tournant, que l'on peut aisément installer ou retirer. Disponible dans de nombreux coloris et finitions, il est présenté dans des bases différentes, en finition bois ou acier.

ES

Declinación de Cell128, Cell72 es la colección de sillones y sofás de dos plazas con respaldo bajo, ideada para responder a los deseos de una composición creativa. Refinado y funcional, el espacio de los asientos puede completarse con una mesa pequeña con soporte giratorio, que se acerca o aleja con facilidad. Disponible en numerosos colores y acabados, se presenta con bases diferentes, en acabado madera o acero.

PREMI AWARDS

Good Design 2020







CELL72 POLTRONA ARMCHAIR

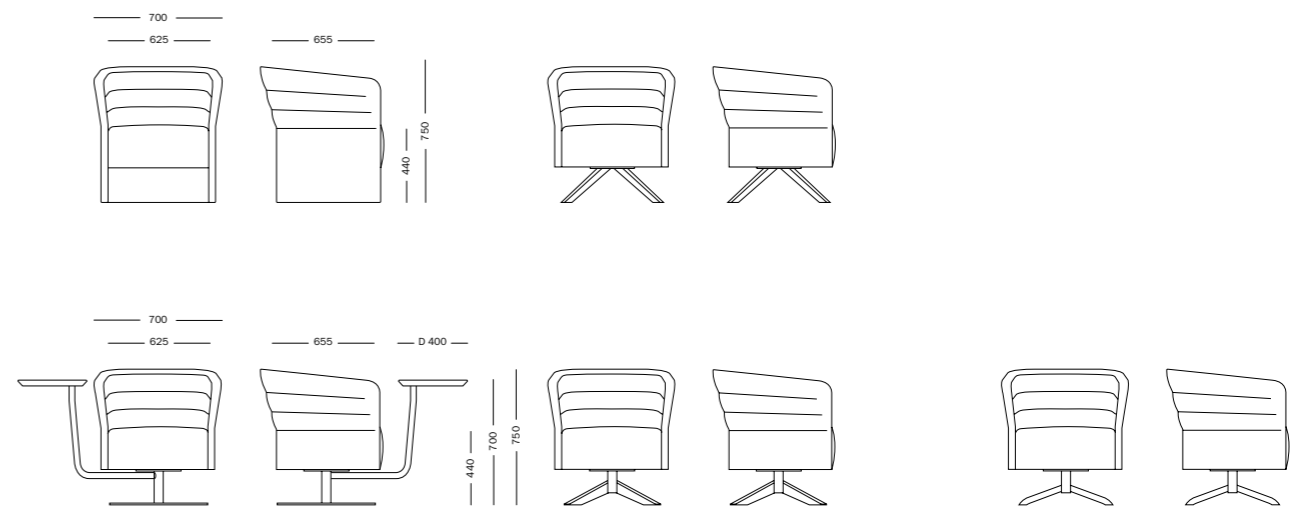

CELL72 DIVANO 2 POSTI 2-SEATER SOFA

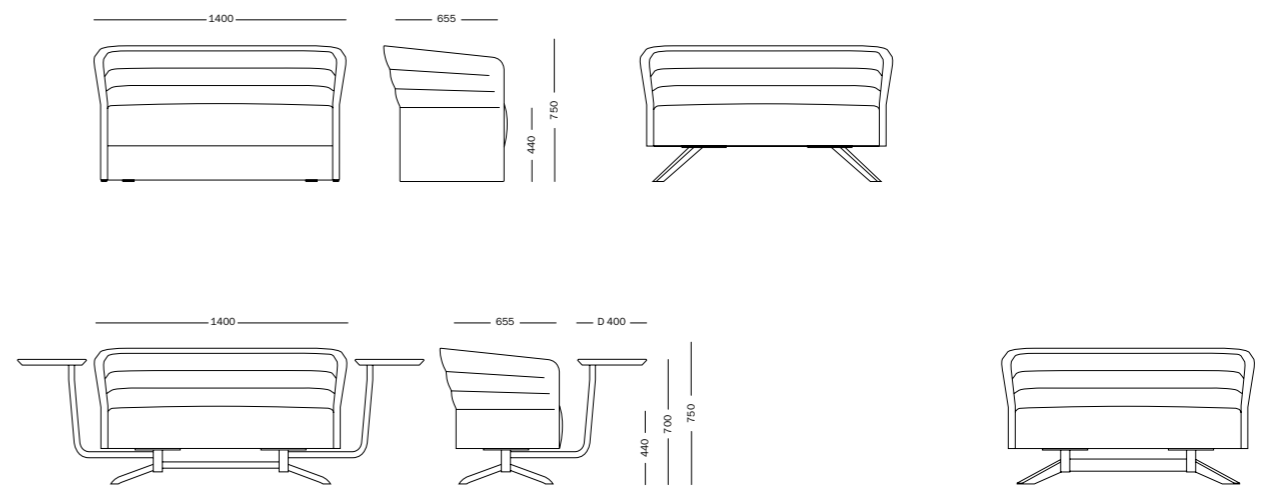



CELL75

—
Dorigo Design 2015

—
IT

Cell75 è il sistema di poltroncine e divani, declinazione semplificata della collezione Cell128, ideale per ambienti contract e di grande ricezione.

—
EN

Cell75 is the range of small armchairs and sofas, a simplified version of the Cell128 collection, ideal for contract and large reception areas.

—
DE

Cell75 ist ein System aus Lehnstühlen und Sofas, eine vereinfachte Abwandlung der Kollektion Cell128, ideal für Objekteinrichtung und große Besucherräume.

—
FR

Cell75 est composé de fauteuils et de canapés, une déclinaison simplifiée de la collection Cell128; l'idéal pour les collectivités tout comme pour les grandes réceptions.

—
ES

Cell75 es el sistema de butacas y sofás, representación simplificada de la colección Cell128, ideal para entornos comunitarios y de gran recepción.

—
PREMI AWARDS

Good Design 2020



Cell75 Armchair

Cell75 2-seater sofa - Armchair



CELL75 POLTRONA ARMCHAIR

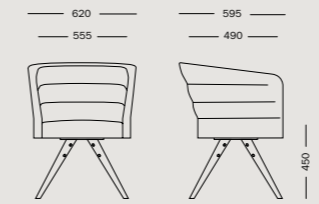

CELL75 DIVANO 2 POSTI 2-SEATER SOFA

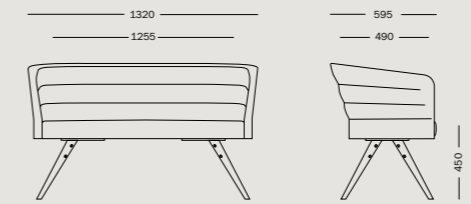



TOBI

Elena Trevisan 2022

IT

Tobi è la famiglia di divani progettata da Elena Trevisan. Concepito per coprire qualsiasi esigenza di spazio, è disponibile in tre dimensioni: da 3, 2 e da 1 posto e mezzo. Seducente in contesti classici, perfetto in ambienti moderni, ideale a casa come nelle lounge di alberghi e spazi pubblici o in ufficio: Tobi ha una struttura in multistrato e massello, con cinghie elastiche sulla seduta, imbottitura in poliuretano espanso a quote differenziate e piedini in legno massello certificati FSC.

EN

Tobi is the collection of sofas designed by Elena Trevisan. Conceived to cover any space requirement, it's available in three sizes: 3, 2 and 1 and a half seats. Enticing in classic settings, perfect in modern environments, ideal at home as it is in hotel lounges and public spaces, as well as in the office: Tobi has a structure in multilayer and solid wood, with elastic belts on the seat, a padding in differentiated-density polyurethane foam and FSC certified solid wood legs.

DE

Tobi ist die von Elena Trevisan entworfene Sofakollektion. Tobi ist in drei Größen erhältlich und passt sich mit 3, 2 oder 1,5 Sitzen jedem Platzbedarf an. Verführerisch in klassischen Umgebungen, perfekt im modernen Ambiente, ideal sowohl zu Hause als auch in Hotel-Lounges und öffentlichen Räumlichkeiten oder im Büro: Tobi hat eine Struktur aus Sperrholz und Massivholz, mit elastischen Gurten auf der Sitzfläche Polsterung aus Polyurethanschaum in verschiedenen Dichten und FSC-zertifizierte Massivholzfüße.

FR

Tobi est la collection de canapés dessinée par Elena Trevisan. Conçu pour répondre à n'importe quelle exigence d'espace, Tobi est disponible en trois dimensions: 3, 2 et 1 place et demie. Séduisant dans des contextes classiques, parfait dans des environnements modernes, idéal chez soi tout comme dans les lounges d'hôtels et d'espaces d'accueil publics ou au bureau: Tobi a une structure en panneaux multicouches et en bois massif, avec bandes élastiques sur l'assise, une rembourrage en polyuréthane expansé à densités variables et des pieds en bois massif certifiés FSC.

ES

Tobi es la colección de sofás diseñada por Elena Trevisan. Pensada para cubrir cualquier necesidad de espacio, está disponible en tres tamaños: 3, 2 y 1 plaza y media. Atractivo en ambientes clásicos, perfecto en entornos modernos, ideal tanto en casa como en salones de hotel y espacios públicos, así como en la oficina: Tobi tiene una estructura en multicapa y madera maciza, con correas elásticas en el asiento, un acolchado en espuma de poliuretano de densidad diferenciada y patas de madera maciza con certificación FSC.







TOBI POLTRONA ARMCHAIR

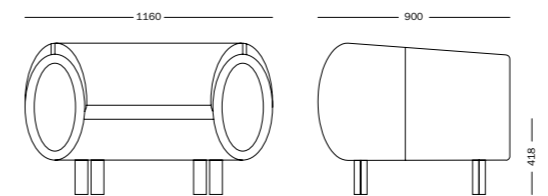

TOBI DIVANO 2 POSTI 2-SEATER SOFA

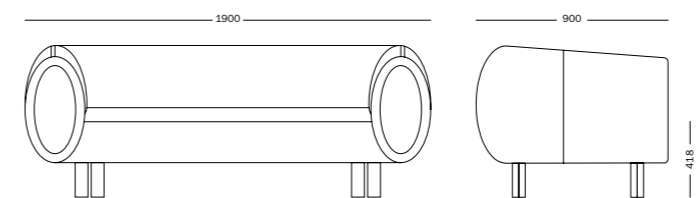

TOBI DIVANO 3 POSTI 3-SEATER SOFA

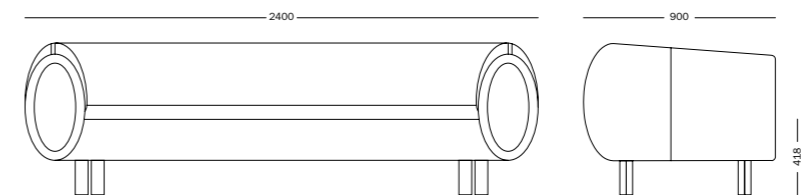



CANAPÈ

IT

Canapè è la collezione di poltrone e divani a due e tre posti dalla forma rigorosa e distintiva, unita a un comfort eccellente, fruibile in ogni tipo di ambiente. L'imbottitura in poliuretano espanso ad alta densità e privo di CFC dello schienale e della profonda seduta garantisce compattezza e inalterabilità dei volumi, mentre la struttura interna realizzata interamente in legno assicura resistenza e solidità. Il modello GL è arricchito da cuciture artigianali con motivo quadrato.

EN

Canapè is the collection of two and threeseater sofas and armchairs with a controlled and distinctive shape, combined with excellent comfort which can be used in every type of environment. The padding in CFC-free and high-density polyurethane foam of the back and the deep seat ensures compactness and shape retention of the volumes, while the inner structure made in wood throughout guarantees strength and solidity. The GL model is enriched with artisan stitching with a square pattern.

DE

Canapè ist eine Kollektion aus Lehnssesseln und zwei- und dreisitzigen Sofas im charakteristischen, rigorosen Design, mit einem exzellenten Komfort, der die Möbel für jedes Ambiente nutzbar macht. Die Polsterung aus PU-Schaum hoher Dichte und frei von FCKW der Rückenlehne und der tiefen Sitzfläche garantiert Kompaktheit und formstabile Volumen, die Innenstruktur aus Holz gibt die nötige Widerstandsfähigkeit und Festigkeit. Das Modell GL wird durch handwerkliche Nähte im Quadratmuster veredelt.

FR

Canapè est la collection de fauteuils et de canapés à deux et trois places de forme rigoureuse et reconnaissable, associée à un excellent confort qui s'adapte à tous les environnements. Le rembourrage en mousse de polyuréthane haute densité et sans CFC du dossier et de l'assise profonde garantit des volumes compacts et inaltérables, tandis que la structure interne entièrement réalisée en bois assure la résistance et la solidité. Le modèle GL est enrichi de coutures artisanales avec motif carré.

ES

Canapè es la colección de sillones y sofás de dos y tres plazas de forma rigurosa y distinguida, que ofrece también un confort excelente, ideal para cualquier tipo de ambiente. El acolchado en espuma de poliuretano de alta densidad y sin CFC del respaldo y del asiento profundo garantiza volúmenes compactos e inalterables, mientras que la estructura interna realizada completamente en madera ofrece resistencia y solidez. El modelo GL se embellece con costuras artesanales de motivo cuadrado.



Canapè Armchair - 2-seater sofa



CANAPÈ POLTRONA ARMCHAIR

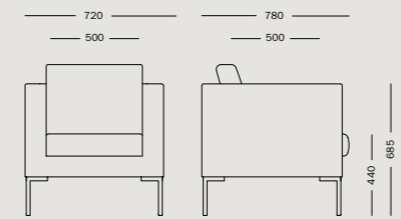

CANAPÈ DIVANO 2 POSTI 2-SEATER SOFA

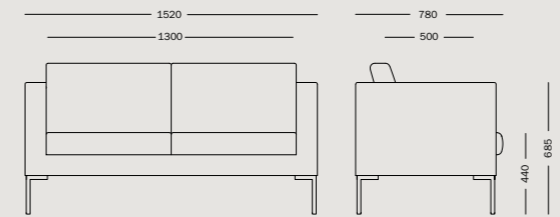

CANAPÈ DIVANO 3 POSTI 3-SEATER SOFA

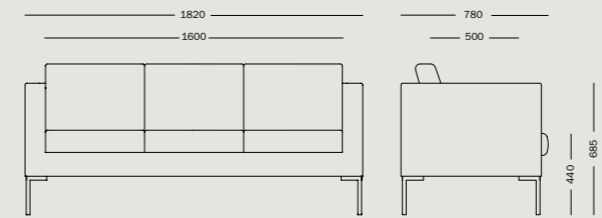



MILOS LOUNGE

Dorigo Design 2022



IT

Linee eleganti e delicate come quelle della capostipite, Milos Lounge è caratterizzata da una seduta monoscocca dalle generose dimensioni, impreziosita da una doppia fodera imbottita per un comfort elevato. I braccioli opzionali e le diverse possibili basi - legno, 4 piedi, 4 razze - la rendono perfetta per le zone lounge, ma anche per gli spazi ibridi dell'office contemporaneo e per gli spazi domestici. Elementi in legno massello, monoscocca realizzata in biopoliuretano e rivestimenti riciclati e riciclabili, applicati senza l'utilizzo di colla, sono gli ingredienti di questa poltrona lounge attenta al comfort e all'ambiente.

EN

Characterized by elegant and smooth lines as its ancestor, Milos Lounge features a generous seat enhanced by a double padded cover for higher comfort. Optional armrests and the different possible bases - wood, 4-feet, 4-star - make it perfect for lounge areas, but also for the hybrid spaces of the contemporary office and domestic spaces. Solid wood elements, monocoque made of bio-polyurethane and recycled and recyclable upholstery, applied without the use of glue, are the ingredients of this comfort and environmentally friendly lounge chair.

DE

Milos Lounge hat die gleichen eleganten und zarten Linien wie sein Vorbild und verfügt über einen großzügigen Monocoque-Sitz, der durch einen doppelt gepolsterten Bezug für hohen Komfort sorgt. Optionale Armlehnen und eine Vielzahl von Gestellen - Holz, 4-Fuß, 4-Speichen - machen ihn perfekt für Lounge-Bereiche, aber auch für die hybriden Räume des modernen Büros und des Wohnbereichs. Massivholzelemente, ein Monocoque aus Bio-Polyurethan und eine recycelte und recycelbare Polsterung, die ohne Klebstoff aufgebracht wird, sind die Zutaten für diesen komfortablen und umweltfreundlichen Sessel.

FR

Avec des lignes élégantes et délicates comme celles de son ancêtre, Milos Lounge présente un siège monocoque des dimensions généreuses, rehaussé d'un double rembourrage pour un grand confort. Les accoudoirs en option et les différentes bases possibles - bois, 4 pieds, 4 branches - le rendent parfait pour les espaces de détente, mais aussi pour les espaces hybrides du bureau contemporain et pour les espaces domestiques. Des éléments en bois massif, une monocoque en bio-polyuréthane et un rembourrage recyclé et recyclable, appliqué sans colle, sont les ingrédients de ce fauteuil lounge confortable et écologique.

ES

Con unas líneas tan elegantes y delicadas como las de su progenitor, Milos Lounge cuenta con un asiento monocasco de generosas dimensiones, embellecido por una funda de doble acolchado para un gran confort. Los reposabrazos opcionales y la variedad de bases -madera, 4 pies, 4 radios- la hacen perfecta para las zonas de descanso, pero también para los espacios híbridos de la oficina contemporánea y los espacios domésticos. Elementos de madera maciza, un monocasco de biopoliuretano y una tapicería reciclada y reciclable, aplicada sin utilizar pegamento, son los ingredientes de este sillón de confort y ecológico.









MILOS LOUNGE POLTRONA ARMCHAIR

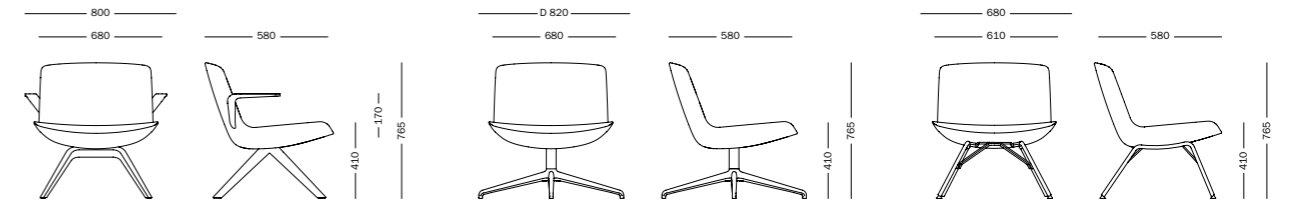



JOY

Sergio Bellin 2017

IT

Il pouf Joy è la sintesi di una linearità geometrica inedita, giocata su sottili proporzioni e misurate inclinazioni, messe in risalto da un armonioso contrasto cromatico. Un elemento d'arredo dalle molteplici destinazioni d'uso, funzionali e decorative. Una seduta attraente alla vista e confortevole all'esperienza. Disponibile in diverse varianti e personalizzabile nel caratteristico e raffinato binomio cromatico.

EN

The Joy pouf embodies original geometric linearity, played out on slim proportions and measured slants, enhanced by a pleasing colour contrast. An item of furniture with multiple intended uses, functional and decorative. An attractive seat, comfortable in use. Available in different versions with customisation of the distinctive and sophisticated two-colour scheme.

DE

Die Fußbank Joy, Inbegriff einer neuartigen, geometrischen Linearität, setzt auf schlanke Proportionen und maßvolle Schrägen, die durch die Harmonie farblicher Kontraste betont werden. Ein Einrichtungselement, das vielfältig zu verwenden ist, zweckmäßig und dekorativ. Sitzmöbel, attraktiv für das Auge und bequem bei der Benutzung. Erhältlich in mehreren Varianten und Möglichkeit für individuelle Gestaltung der charakteristischen Zweifarben-Kombination.

FR

Le pouf Joy est la synthèse de motifs linéaires et géométriques inédits, qui jouent avec des proportions subtiles et des inclinaisons mesurées, relevées par un contraste de couleurs harmonieux. Un élément aux multiples destinations à la fois fonctionnelles et décoratives. Une assise attrayante pour les yeux dont on découvre le confort dès qu'on l'essaye. Disponible dans différentes versions et personnalisable dans son binôme de couleurs caractéristique et raffiné.

ES

El puf Joy es la síntesis de una linealidad geométrica inédita, articulada en proporciones sutiles e inclinaciones moderadas, que se destacan gracias a un contraste cromático armonioso. Un elemento decorativo de múltiples empleos, funcionales y decorativos. Un asiento de aspecto atractivo y cómodo al uso. Disponible en distintas variantes y personalizable según el binomio cromático característico y refinado.



JOY POUF

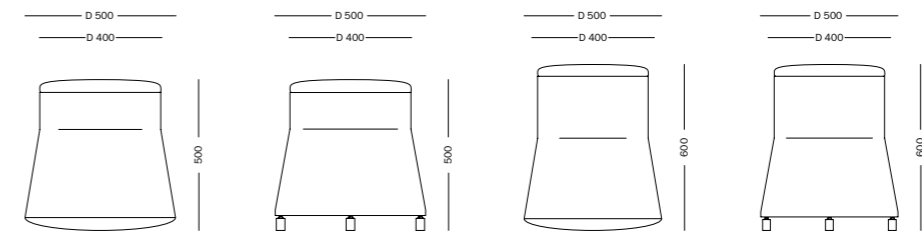



DODO

Sergio Bellin 2017

IT

Dodo è il pouf dallo stile contemporaneo, che arreda con gusto e intelligenza qualsiasi tipo di spazio. Disponibile in tre altezze e due misure di diametro diverse, Dodo presenta un sedile imbottito e un corpo rivestiti in tessuto, componibili cromaticamente in numerose combinazioni originali e divertenti. Dotato di maniglia verticale in cuoio naturale o tessuto, vivacizza sale d'attesa, uffici privati e aree di condivisione.

EN

Dodo is a pouf with a contemporary style that brings a smart, elegant touch to any setting. Available in three different heights and two diameters, Dodo has padded seat and body upholstered with fabric, that can be combined in numerous original and bright colour schemes. Fitted with a genuine leather or fabric vertical handle, Dodo makes a lively addition to waiting rooms, private offices and public spaces.

DE

Dodo ist ein Hocker im zeitgemäßen Stil, der jeden Raum intelligent und mit Geschmack gestalten kann. Dodo ist in drei Höhen und zwei verschiedenen Durchmessern erhältlich und besteht aus einem gepolsterten Sitz und einem mit Stoff bezogenen Korpus, der in vielen originellen und witzigen Farbkombinationen erhältlich ist. Ausgestattet mit einem vertikalen Griff aus echtem Leder oder Stoff, sorgt er für lebhaftere Akzente in Warteräumen, Büros und kollektiven Bereichen.

FR

Dodo est un pouf de style contemporain qui meuble avec goût et intelligence n'importe quel type d'espace. Disponible en trois hauteurs et deux diamètres différents, Dodo présente une assise rembourrée et une structure revêtu en tissu, créant de nombreuses combinaisons de couleurs, originales et amusantes. Muni de poignée verticale en cuir naturel ou en tissu, il égaye les salles d'attente, les bureaux privés et les zones conviviales.

ES

Dodo es el puf de estilo contemporáneo que decora con gusto e inteligencia cualquier tipo de espacio. Disponible en tres alturas y dos diámetros diferentes, Dodo presenta un asiento acolchado y un cuerpo tapizado con tejido, componibles cromáticamente en numerosas combinaciones originales y divertidas. Equipado con asa vertical de cuero natural o de tela, alegra las salas de espera, las oficinas particulares y las áreas compartidas.



Dodo Pouf



DODO POUF

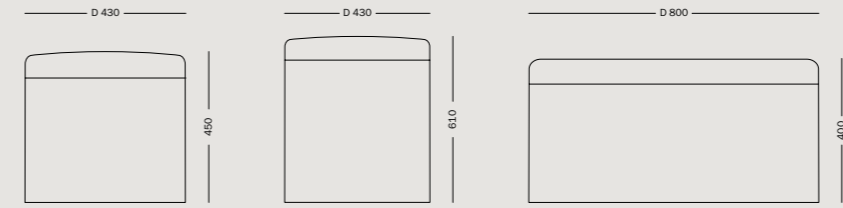

BOMM

AdriAn Blanc 2021

IT

I moduli di Bomm si combinano e ricombinano con semplicità e senza vincoli per offrire una rilassante seduta in una zona lounge o una postazione di lavoro informale in uno spazio outdoor dove condividere idee e creatività. La gamma Bomm offre la possibilità di creare e ricreare infinite configurazioni combinando 9 diverse strutture in tubolare di acciaio a 6 moduli seduta, con o senza schienale, e 3 moduli tavolino. Un sistema facile da configurare e da adattare alle più diverse esigenze di spazio e di utilizzo. La collezione si completa con una serie di accessori funzionali: tavoletta girevole, appendiabiti e prese USB a scomparsa.

EN

Bomm modules combine easily creating many different configurations suitable for lounge or working areas as well as for an outdoor informal meeting. The Bomm range offers the possibility to create an infinite number of configurations by combining 9 different tubular steel structures with 6 seat modules with or without backrest and 3 table modules. A system that is easy to configure and adapt to different space solutions. The collection is completed with a series of functional accessories: revolving tablet, coat rack and hidden USB sockets.

DE

Die Module von Bomm lassen sich einfach und zwanglos kombinieren und neu zusammenstellen, um einen entspannenden Sitzplatz in einer Lounge oder einen informellen Arbeitsplatz in einem Außenbereich, aber auch einen Treffpunkt zum Austausch von Ideen und Kreativität zu bieten. Das Programm Bomm bietet die Möglichkeit, durch die Kombination von 9 verschiedenen Stahlrohrstrukturen mit 6 Sitzmodulen mit oder ohne Rückenlehne und 3 Tischmodulen unendlich viele Konfigurationen zu schaffen und neu zu gestalten. Ein System, das sich leicht konfigurieren und an die unterschiedlichsten Raum- und Nutzungsanforderungen anpassen lässt. Vervollständigt wird die Kollektion durch eine Reihe von funktionellem Zubehör: Drehtisch, Garderobe und verdeckte USB-Steckdosen.

FR

Bomm modules se combinent et se recombinent avec simplicité et sans contraintes pour offrir un siège cosy en espace lounge ou en poste de travail informel, en intérieur comme en extérieur là où les idées et la créativité peuvent être partagées. La gamme Bomm offre la possibilité de créer des configurations à l'infini en combinant 9 structures différentes en acier tubulaire avec 6 modules de siège, avec ou sans dossier, et 3 modules de table. Un système facile à configurer et à adapter aux diverses exigences d'utilisation et d'espace. La collection est complétée d'accessoires fonctionnels : table pivotante, porte-manteau et prises USB encastrées.

ES

Los módulos de Bomm se combinan y recombinan con sencillez y sin limitaciones para ofrecer un asiento relajante en una zona lounge o un puesto de trabajo informal en un espacio exterior, pero también una zona de encuentro para compartir ideas y creatividad. La gama Bomm ofrece la posibilidad de crear y recrear infinitas configuraciones combinando 9 estructuras tubulares de acero diferentes con 6 módulos de asiento con o sin respaldo y 3 módulos de mesa. Un sistema fácil de configurar y adaptar a las más diversas necesidades de espacio y uso. La colección se completa con una serie de accesorios funcionales: mesa giratoria, perchero y tomas USB ocultas.





Bomm Modular system





Bomm Modular system



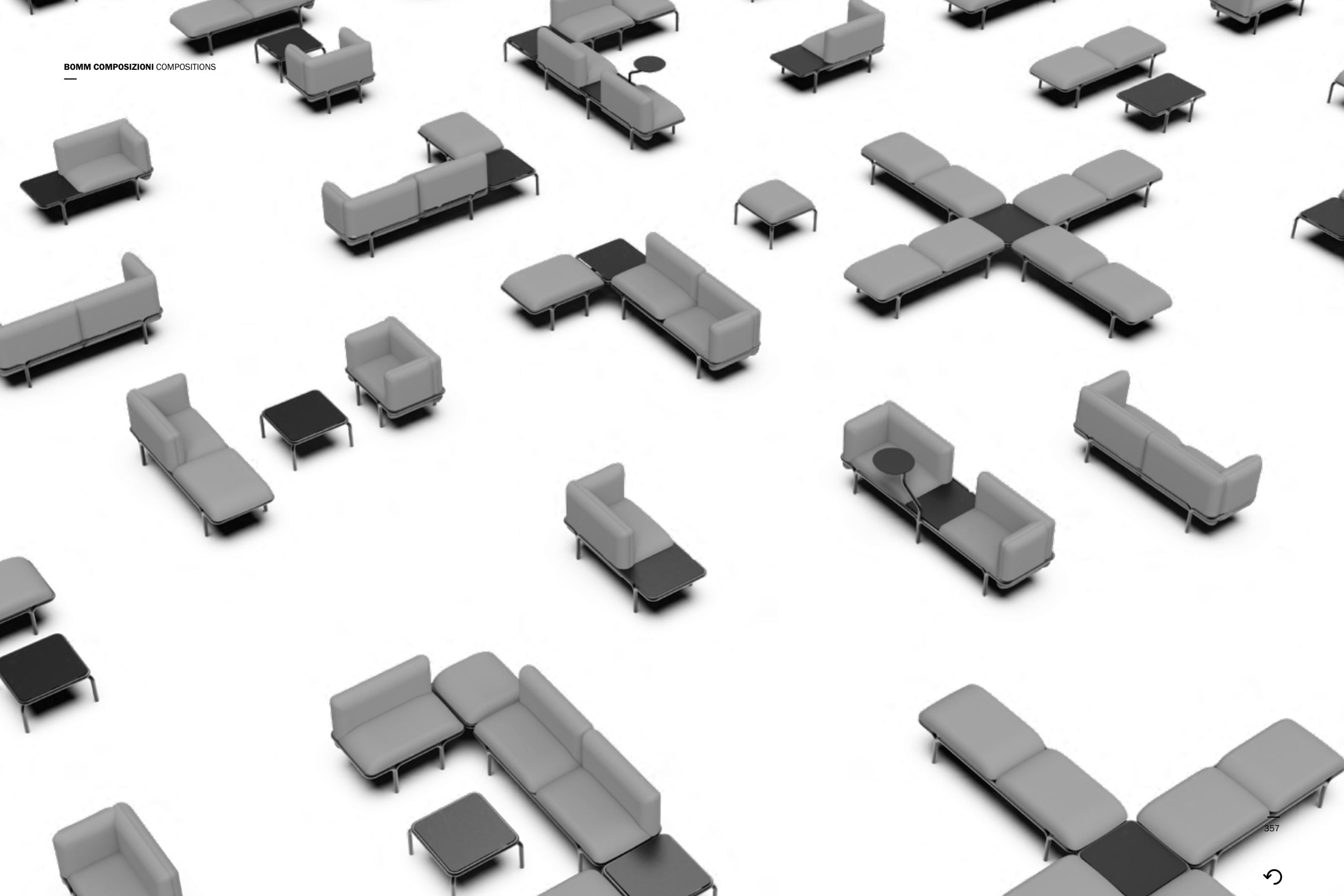

BOMM STRUTTURE STRUCTURES

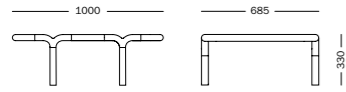

MODULO A - Struttura per un cuscino rettangolare o un tavolo rettangolare grande
MODULE A - Structure for one rectangular cushion or one big rectangular table

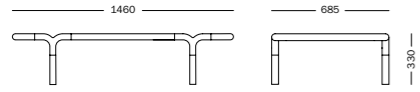

MODULI B/C - Struttura per un cuscino rettangolare e un tavolo rettangolare piccolo a destra/sinistra
MODULES B/C - Structure for one rectangular cushion and one small rectangular table on the right/left

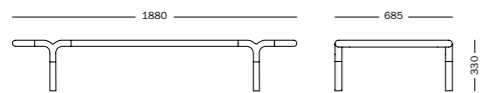

MODULO D - Struttura per due cuscini rettangolari
MODULE D - Structure for two rectangular cushions

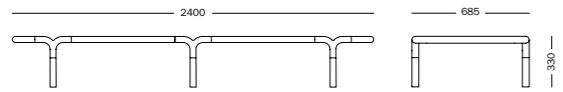

MODULO E - Struttura per due cuscini rettangolari e un tavolo rettangolare piccolo centrale
MODULE E - Structure for two rectangular cushions and one small central rectangular table

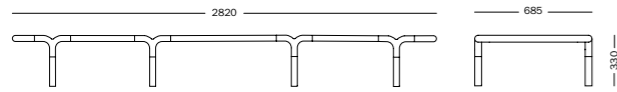

MODULO F - Struttura per tre cuscini rettangolari
MODULE F - Structure for three rectangular cushions

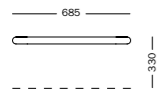

MODULO H - Struttura sospesa quadrata per connessione da 2 a 4 moduli
MODULE H - Suspended square structure for the connection of 2 to 4 modules

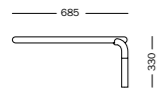

MODULO I - Struttura angolare quadrata per connessione di 2 moduli
MODULE I - Corner square structure for the connection of 2 modules

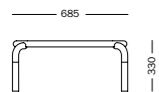

MODULO L - Struttura stand alone per un cuscino quadrato o un tavolo quadrato piccolo
MODULE L - Stand alone structure for one square cushion or one small square table

BOMM CUSCINI CUSHIONS

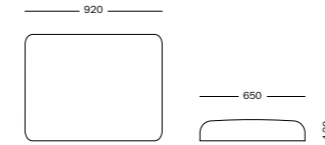

MODULO 1 - Cuscino rettangolare
MODULE 1 - Rectangular cushion

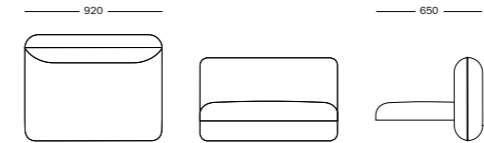

MODULO 2 - Cuscino rettangolare, schienale
MODULE 2 - Rectangular cushion, backrest

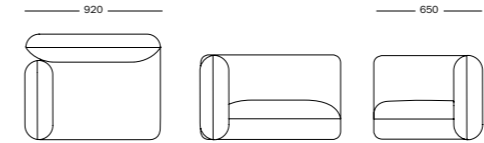

MODULO 3 - Cuscino rettangolare, schienale, bracciolo destro
MODULE 3 - Rectangular cushion, backrest, right armrest

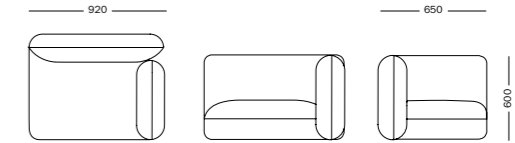

MODULO 4 - Cuscino rettangolare, schienale, bracciolo sinistro
MODULE 4 - Rectangular cushion, backrest, left armrest

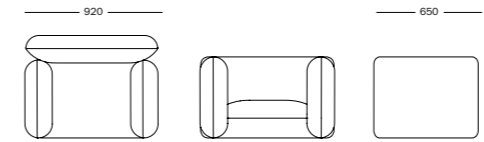

MODULO 5 - Cuscino rettangolare, schienale, braccioli
MODULE 5 - Rectangular cushion, backrest, armrests

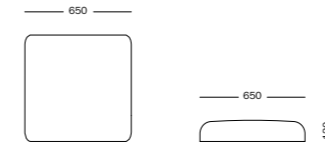

MODULO 6 - Cuscino quadrato
MODULE 6 - Square cushion



BOMM RIPIANI TABLE TOPS

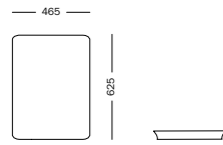

MODULO T1 - Tavolo piccolo rettangolare
MODULE T1 - Small rectangular table

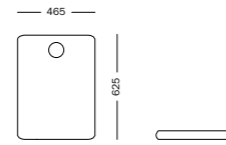

MODULO T1 - Tavolo piccolo rettangolare, 2 prese USB, ricarica wireless
MODULE T1 - Small rectangular table, 2 USB plugs, wireless recharge system

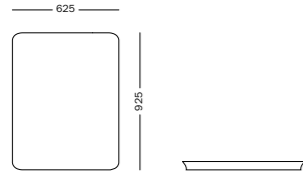

MODULO T3 - Tavolo grande rettangolare
MODULE T3 - Big rectangular table

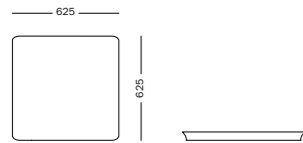

MODULO T5 - Tavolo quadrato
MODULE T5 - Square table

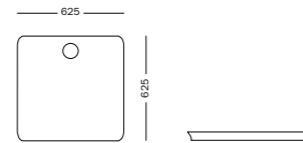

MODULO T5 - Tavolo quadrato, 2 prese USB, ricarica wireless
MODULE T5 - Square table, 2 USB plugs, wireless recharge system

BOMM ACCESSORI ACCESSORIES

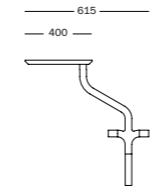

Tavoletta rotonda girevole
Round swivelling tablet

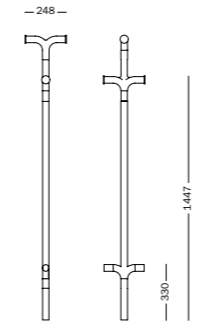

Appendiabiti
Coat hanger





LIDO

Dorigo Design 2022



IT

Lido è un sistema componibile di pouf studiato per personalizzare l'attesa. Forme semplici e basilari permettono una modularità e customizzazione infinita. Grazie a un elemento netto e minimale, quello del taglio, è possibile combinare moduli e accessori, per creare la soluzione più adatta alle esigenze singole. La collezione offre un'ampia gamma di moduli di seduta, disponibili in diverse dimensioni e forme, abbinabili a schienali, braccioli, tavolini e altri accessori. Lido è completamente sfoderabile, mentre i suoi componenti sono facilmente riparabili e disassemblabili.

EN

Lido is a modular system of poufs designed to personalize the lounge areas. Simple and basic shapes allow infinite modularity and customization. Thanks to a clean and minimal element, the cut, it is possible to combine modules and accessories, to create the most suitable solution for individual needs. The collection offers a wide range of seating modules, available in different sizes and shapes, which can be combined with backrests, armrests, tables and other accessories. Lido upholstery is completely removable and its components are easily repairable and disassembled.

DE

Lido ist ein modulares Sitzkissen-System, mit dem sich Wartebereiche individuell gestalten lassen. Einfache und grundlegende Formulare ermöglichen eine unendliche Modularität und Anpassung. Dank eines klaren und minimalistischen Elements, nämlich des Schnitts, ist es möglich, Module und Zubehör zu kombinieren, um die für die individuellen Bedürfnisse am besten geeignete Lösung zu schaffen, ein fast maßgeschneiderter Prozess. Die Kollektion bietet eine große Auswahl an Sitzmodulen in verschiedenen Größen und Formen, die mit Rückenlehnen, Armlehnen, Tischen und anderem Zubehör kombiniert werden können. Lido hat vollständig abnehmbare Bezüge, während seine Komponenten leicht zu reparieren und zu demontieren sind.

FR

Lido est un système modulable de poufs étudié pour personnaliser l'attente. Des formes simples et basiques permettent une modularité et personnalisation infinies. Grâce à un élément défini et minimaliste, celui de la coupe, il est possible de combiner des modules et des accessoires, pour créer la solution la plus adaptée aux besoins de chacun, un procédé similaire à celui de la confection. La collection offre une large gamme de modules d'assise, disponibles en plusieurs tailles et formes, associables à des dossiers, des accoudoirs, des tables et autres accessoires. Lido est entièrement déhoussable, et ses composants peuvent être facilement réparés et désassemblés.

ES

Lido es un sistema modular de pufs diseñado para personalizar los espacios de espera. Las formas simples y básicas permiten una modularidad y personalización infinitas. Gracias a un elemento claro y mínimo, el del corte, se pueden combinar módulos y accesorios para crear la solución más adecuada a las necesidades individuales, un proceso casi a medida. La colección ofrece una amplia gama de módulos de asiento, disponibles en diferentes tamaños y formas, que pueden combinarse con respaldos, reposabrazos, mesas y otros accesorios. Lido es completamente desmontable, mientras que sus componentes son fácilmente reparables y desmontables.



PREMI AWARDS
Good Design 2022









LIDO STRUTTURE STRUCTURES

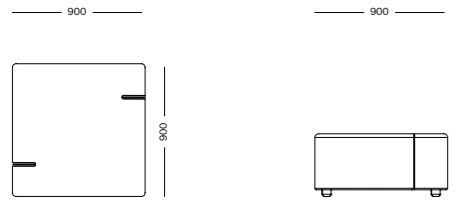

MODULO A - Modulo quadrato
MODULE A - Square module

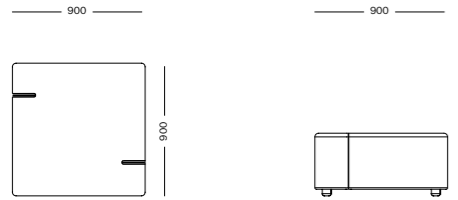

MODULO B - Modulo quadrato
MODULE B - Square module

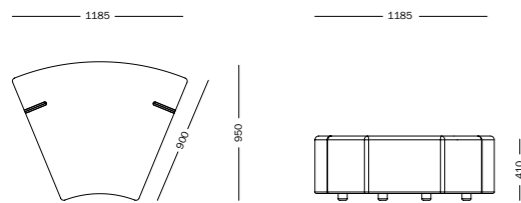

MODULO C - Modulo angolare 45°
MODULE C - 45° angular module

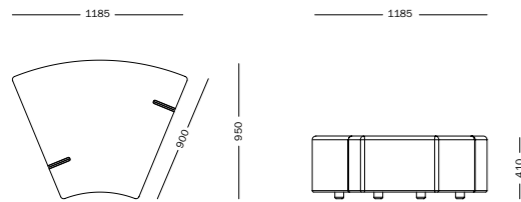

MODULO D - Modulo angolare 45°
MODULE D - 45° angular module

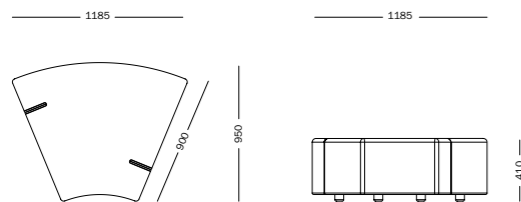

MODULO E - Modulo angolare 45°
MODULE E - 45° angular module

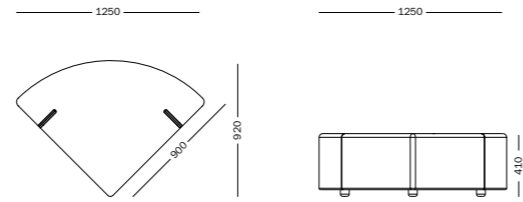

MODULO F - Modulo angolare 90°
MODULE F - 90° angular module

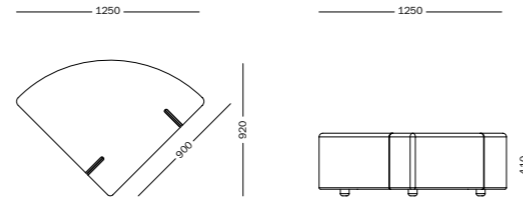

MODULO G - Modulo angolare 90°
MODULE G - 90° angular module

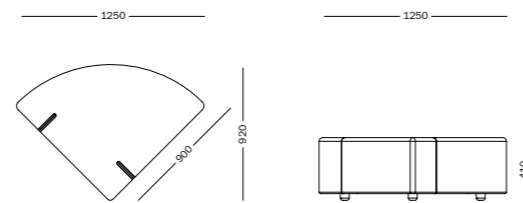

MODULO H - Modulo angolare 90°
MODULE H - 90° angular module

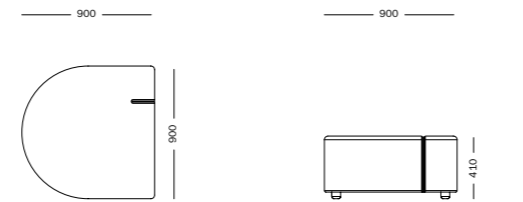

MODULO I - Modulo terminale arrotondato
MODULE I - Rounded end module

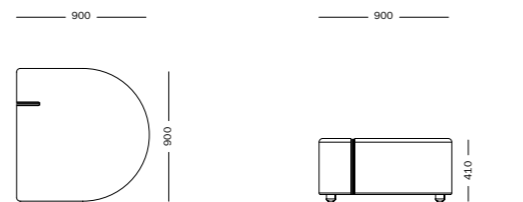

MODULO L - Modulo terminale arrotondato
MODULE L - Rounded end module

LIDO ACCESSORI ACCESSORIES

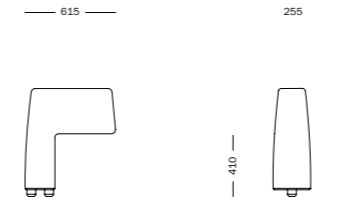

MODULO M - Bracciolo
MODULE M - Armrest

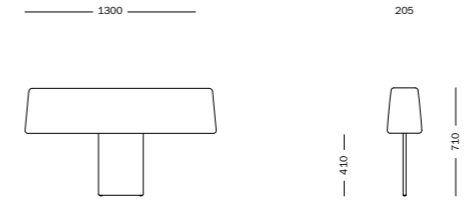

MODULO N - Schienale
MODULE N - Back

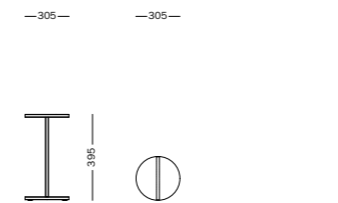

MODULO 1 - Tavolino
MODULE 1 - Table

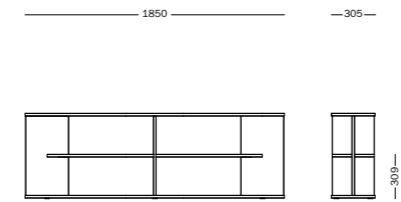

MODULO 3 - Libreria bassa
MODULE 3 - Low bookshelf

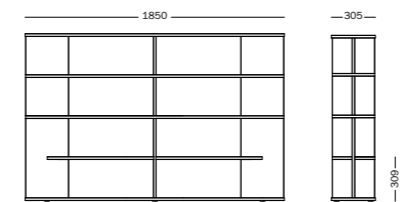

MODULO 4 - Libreria alta
MODULE 4 - High bookshelf



DROP

Zakaria Khalfaoui 2022

IT

Drop è un sistema modulare, completamente disassemblabile, costruito su tre elementi: schienale, bracciolo, seduta. Come i sistemi drag&drop digitali, è pensato per essere semplice e liberamente componibile. Il design della gamba richiama le forme di una goccia, mentre schienali e braccioli rivelano un gioco interessante tra forme curve e diamantature pronunciate.

EN

Drop is a modular system, completely disassemblable, built on three elements: backrest, armrest, seat. Like digital drag&drop systems, it is designed to be simple and freely modular. The design of the leg recalls the shape of a drop, while backrests and armrests reveal an interesting combination of curves and pronounced diamond shapes.

DE

Drop ist ein modulares System, das vollständig zerlegbar ist und aus drei Elementen besteht: Rückenlehne, Armlehne und Sitz. Wie digitale Drag&Drop-Systeme ist es einfach und frei modular aufgebaut. Das Design der Beine erinnert an die Form eines Tropfens, während die Rücken- und Armlehnen ein interessantes Wechselspiel zwischen geschwungenen Formen und ausgeprägten Rauten zeigen.

FR

Drop est un système modulable, qui peut être entièrement désassemblé, construit sur trois éléments : dossier, accoudoir, assise. Comme les systèmes drag&drop du numérique, il est pensé pour pouvoir être composé simplement et librement. Le design du pied rappelle les formes d'une goutte, tandis que les dossiers et les accoudoirs révèlent un jeu intéressant entre formes courbes et diamantages prononcés.

ES

Drop es un sistema modular, completamente desmontable, construido sobre tres elementos: respaldo, reposabrazos y asiento. Al igual que los sistemas digitales drag&drop, está diseñado para ser sencillo y libremente componible. El diseño de las patas recuerda la forma de una gota, mientras que los respaldos y los reposabrazos revelan un interesante juego entre formas curvas y rombos pronunciados.





—
Drop Modular system





—
Drop Modular system



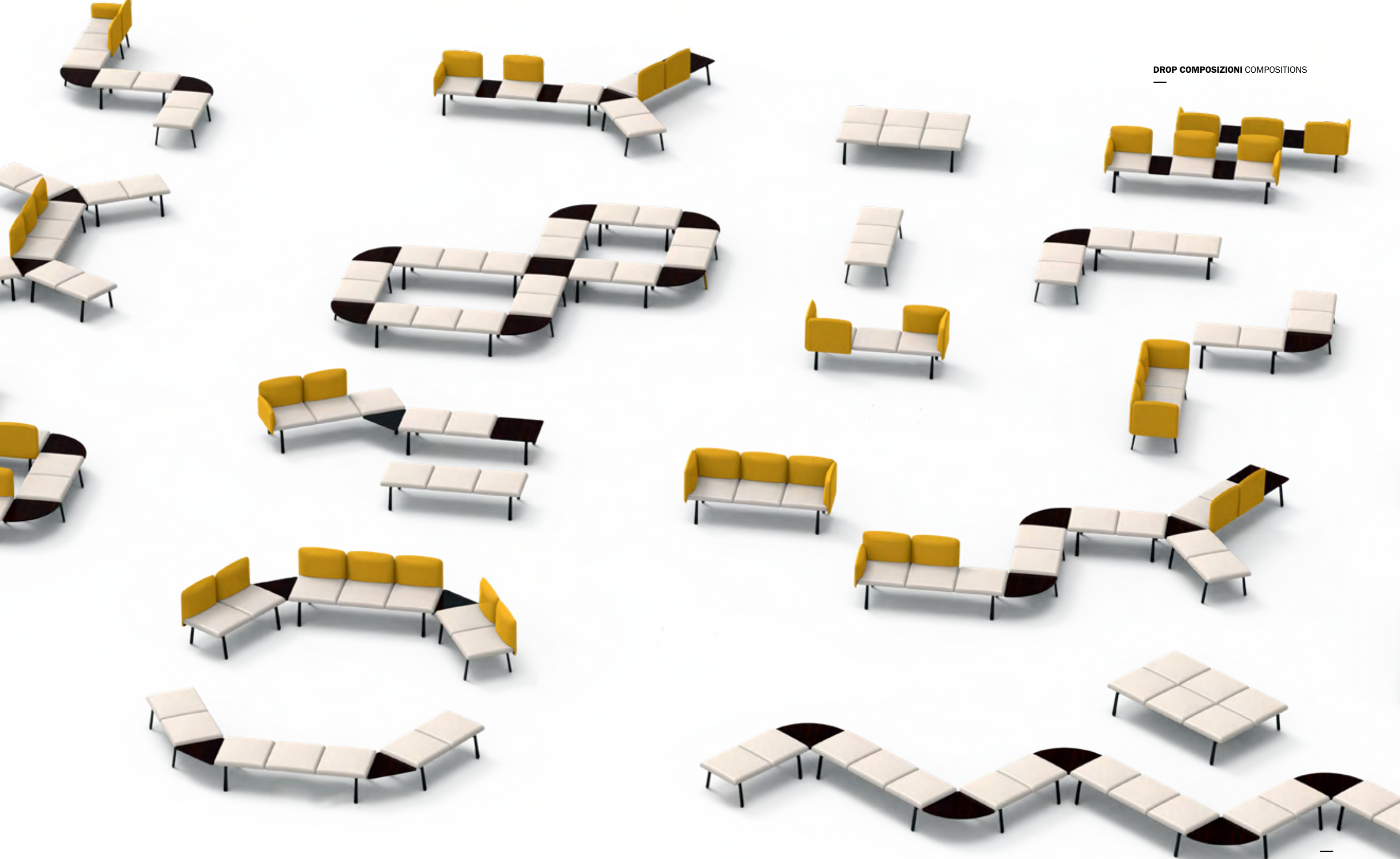

DROP STRUTTURE STRUCTURES

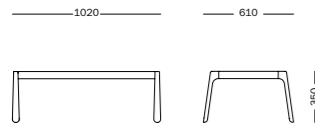

MODULO B - Struttura per 2 unità
MODULE B - Structure for 2 units

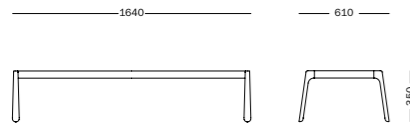

MODULO C - Struttura per 3 unità
MODULE C - Structure for 3 units

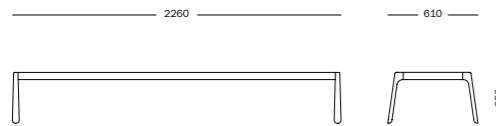

MODULO D - Struttura per 4 unità
MODULE D - Structure for 4 units

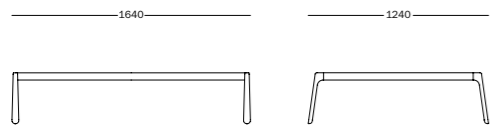

MODULO E - Struttura doppia per 3 unità per lato
MODULE E - Double structure for 3 units per side

DROP CUSCINI CUSHIONS

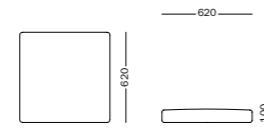

MODULO 1 - Modulo Seduta
MODULE 1 - Seating Module



MODULO 2 - Schienale
MODULE 2 - Backrest

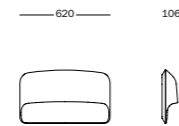

MODULO 3 - Bracciolo basso destro
MODULE 3 - Right low armrest

MODULO 4 - Bracciolo basso sinistro
MODULE 4 - Left low armrest

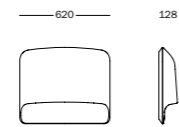

MODULO 5 - Bracciolo alto destro
MODULE 5 - Right high armrest

MODULO 6 - Bracciolo alto sinistro
MODULE 6 - Left high armrest

DROP TOP TAVOLINI TABLE TOPS

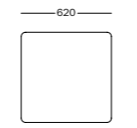

MODULO T1 - Top tavolino quadrato, 1 unità
MODULE T1 - Square table top, 1 unit

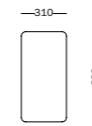

MODULO T2 - Top tavolino rettangolare, ½ unità
MODULE T2 - Rectangular table top, ½ unit

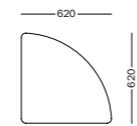

MODULO T3 - Top tavolino ¼ di cerchio
MODULE T3 - ¼ circle table top

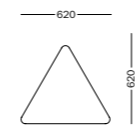

MODULO T4 - Top tavolino triangolare
MODULE T4 - Triangular table top





USE ME

Paolo Scagnellato, Emanuele Bertolini, Jeremiah Ferrarese 2016

IT

Use Me è un sistema di tavolini polifunzionali dal design unico e all'avanguardia. Linee minimal ed essenziali danno forma a un complemento strategico per l'ottimizzazione dello spazio e il comfort nell'utilizzo dei device contemporanei. Il piano, inclinabile a 30°, presenta un sistema di appoggio, che garantisce un'ottimale visualizzazione dello schermo in posizione ergonomica.

EN

Use Me is a system of multi-functional tables with a unique and cutting-edge design. Minimalist and understated lines shape a strategic small furniture item for the optimisation of space and comfort when using contemporary devices. The top, with possible slant of 30°, has a support system which ensures optimal visualisation of the screen in an ergonomic position.

DE

Use Me ist ein System kleiner, multifunktionaler Tische im einzigartigen, innovativen Design. Minimalistische, essentielle Linien geben einem strategischen Wohnzubehör Form, um den Raum und den Komfort moderner Geräte optimal zu nutzen. Die auf 30° schräg stellbare Platte garantiert durch die besondere Auflage eine optimale Sicht auf den Schirm in ergonomischer Position.

FR

Use Me est un assemblage de tables multifonctionnelles au design unique et avant-gardiste. Ses lignes minimalistes et essentielles constituent le complément stratégique idéal pour optimiser l'espace et utiliser les équipements contemporains sans renoncer au confort. Le plateau, inclinable à 30°, présente un système de support qui permet de voir parfaitement l'écran dans une position ergonomique.

ES

Use Me es un sistema de mesas polifuncionales de diseño exclusivo y vanguardista. Las líneas minimalistas y esenciales crean un complemento estratégico para la optimización del espacio y el confort en el uso de dispositivos contemporáneos. El tablero se inclina de 30° y presenta un sistema de apoyo que garantiza una óptima visualización de la pantalla en posición ergonómica.

PREMI AWARDS

Red Dot 2016

ADI selection 2016

Good Design 2016

Grandesign Etico 2016





—
Use Me Table





USE ME TAVOLO TABLE

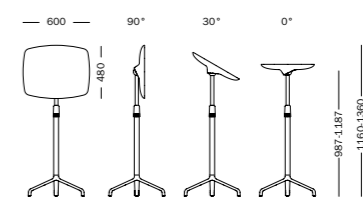
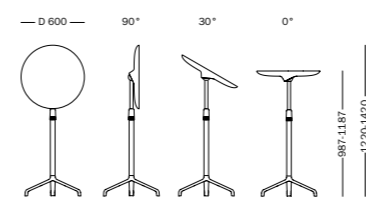
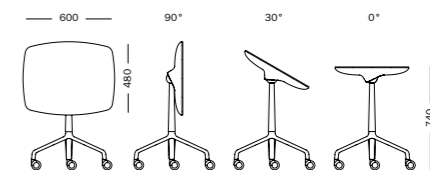
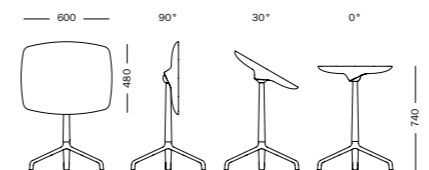
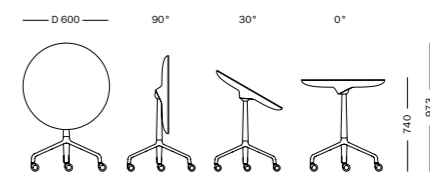
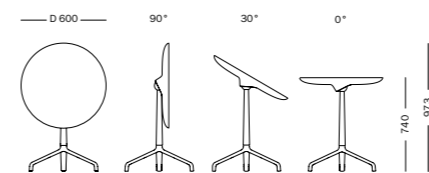



REST

Dorigo Design 2022

IT

Eleganti linee caratterizzano la base in legno massello di Rest. Disponibile in due finiture per la base (Faggio tinto naturale e Faggio tinto nero) e in due dimensioni, Rest è il perfetto complemento per uno spazio intimo ed essenziale.

EN

Elegant lines characterise Rest solid wood base. The base available in two finishes (Beech natural and black painted) and in two dimensions, Rest is the perfect complement for an intimate and essential space.

DE

Elegante Linien kennzeichnen den Massivholzsockel von Rest. Erhältlich in zwei Ausführungen für den Sockel (Buche natur gebeizt und Buche schwarz gebeizt) und in zwei Größen, ist Rest die perfekte Ergänzung für einen intimen und essentiellen Raum.

FR

Des lignes élégantes caractérisent la base en bois massif de Rest. Disponible en deux finitions pour la base (hêtre teinté naturel et hêtre teinté noir) et en deux tailles, Rest est le complément parfait pour un espace intime et essentiel.

ES

Las líneas elegantes caracterizan la base de madera maciza de Rest. Disponible en dos acabados para la base (haya teñida natural y haya teñida negra) y en dos tamaños, Rest es el complemento perfecto para un espacio íntimo y esencial.

Rest Table



REST TAVOLO TABLE





FIL

Dorigo Design 2017

IT

Fil veste di sottili incontri di linee una collezione di tavoli. Un complemento d'arredo perfettamente integrabile in ambienti di vario stile, sia a uso decorativo che funzionale.

EN

Fil dresses with intersecting slim lines a collection of tables. A small furniture item that can be installed perfectly in spaces with different styles, both for decorative and functional use.

DE

Fil bekleidet mit schlanken Linien eine Tischkollektion. Ein Einrichtungszubehör, das sich perfekt in stilistisch unterschiedliche Räume einfügt und ebenso dekorative wie funktionelle Aufgaben erfüllen kann.

FR

Fil habille, à travers des rencontres subtiles, une collection de tables. Un complément de mobilier parfaitement intégrable dans des pièces de différent style, soit comme élément décoratif soit comme élément fonctionnel.

ES

Fil luce uniones impalpables de líneas en una colección de mesas. Un complemento decorativo que se integra a la perfección en entornos de estilos diferentes, por uso estético y funcional.

Fil Table



FIL TAVOLO TABLE

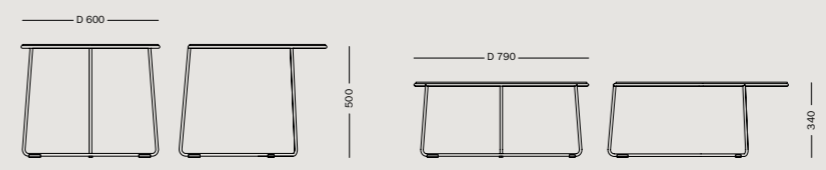

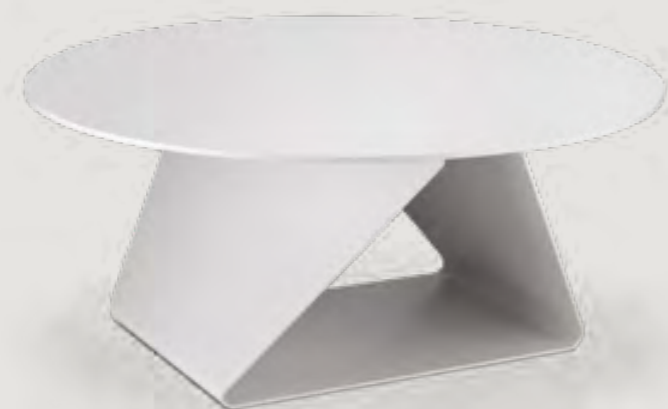

TOV

Dorigo Design 2017

IT

Tov è la collezione di tavoli per ogni tipo di ambiente, perfettamente integrabile in qualsiasi contesto, dall'office, al contract, allo spazio casa. Disponibile in due varianti altezza, la collezione Tov rappresenta un omaggio all'eterna bellezza del dettaglio progettuale.

EN

Tov is the collection of tables for every type of space which can be integrated seamlessly in any contexts, from office to contract and the home. Available in two different heights, the Tov collection symbolises a tribute to the eternal beauty of design details.

DE

Tov ist eine Kollektion von Tischen für jedes Ambiente, perfekt integrierbar in Büro-, Objekt- und Wohnungseinrichtungen. Die Kollektion Tov, erhältlich in zwei verschiedenen Höhen setzt der unvergänglichen Schönheit von Design ein Denkmal.

FR

Tov est la collection de tables adaptées à toutes sortes de pièces, parfaitement intégrables à n'importe quel contexte, du bureau à la collectivité en passant par la maison. Disponible en deux hauteurs différentes, la collection Tov est un hommage à l'éternelle beauté du détail dans la conception.

ES

Tov es la colección de mesas para cada tipo de local, que se integra a la perfección en cualquier entorno: laboral, comunitario y doméstico. Disponible en dos alturas diferentes, la colección Tov representa un homenaje a la eterna belleza del detalle de proyecto.

Tov Table



TOV TAVOLO TABLE

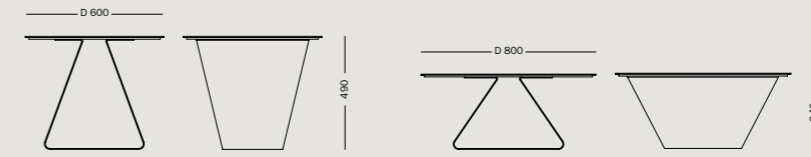



BISTROT

Dorigo Design 2022

IT

Con base in acciaio verniciato in tre altezze e top in diverse finiture, il tavolo Bistrot è adatto sia ad ambienti indoor che outdoor.

EN

With painted steel base in three heights and top in different finishes, the Bistrot table is suitable for both indoor and outdoor use.

DE

Erhältlich in zwei Ausführungen für den Sockel (Buche natur gebeizt und Buche schwarz gebeizt) und in zwei Größen, ist Rest die perfekte Ergänzung für einen intimen und essentiellen Raum.

FR

Avec une base en acier, en trois hauteurs et avec un plateau en différentes finitions, la table Bistrot convient aussi bien à l'intérieur qu'à l'extérieur.

ES

Con una base de acero pintado en tres alturas y un tablero en diferentes acabados, la mesa Bistrot es adecuada tanto para interiores como para exteriores.



BISTROT TAVOLO TABLE

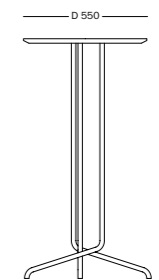
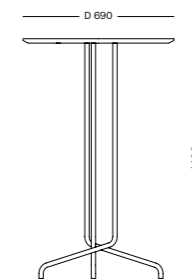
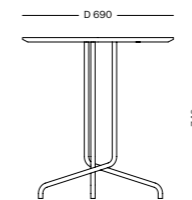
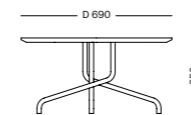



TAB

—
Paolo Scagnellato, Emanuele Bertolini, Jeremiah Ferrarese 2017

—
IT

Tab è il sistema di tavolini disponibile in tre altezze. Il piano rotondo è proposto in bianco o nero. Un prezioso elemento passepartout per ogni tipo di ambiente.

—
EN

Tab is the system of coffee tables available in three heights. The round top comes in white or black. An invaluable multitasker for every type of space.

—
DE

Tab ist ein System kleiner Tische, die in drei Höhen. Die Platte wird in Weiß und Schwarz. Ein wertvolles Einrichtungselement, das sich jedem Raum anpassen kann.

—
FR

Tab est la famille de tables basses disponibles en trois hauteurs. Le plateau est proposé en blanc et en noir. Un précieux élément passepartout pour tous types de lieux.

—
ES

Tab es el sistema de mesas de centro disponibles en tres alturas. El tablero se propone en blanco y negro. Un elemento comodín precioso para cada tipo de espacio.





TAB TAVOLO TABLE

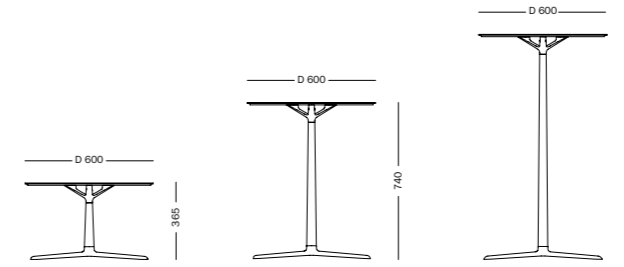

DESIGNERS

—



Dorigo Design



Zakaria Khalfaoui



Paolo Scagnellato, Emanuele Bertolini, Jeremiah Ferrarese



AdriAn Blanc



Baldanzi & Novelli



Elena Trevisan



INDEX

—

AMBER

Tavolo
Table 295

BISTROT

Tavolo
Table 401

BODY

Direzionale - Manager - Meeting
Executive - Manager - Meeting 141

BOMM

Sistema componibile
Modular system 351

CANAPÉ

Poltrona - Divano 2 posti - Divano 3 posti
Armchair - 2-seater sofa - 3-seater sofa 331

CELL72

Poltrona - Divano 2 posti
Armchair - 2-seater sofa 315

CELL75

Poltrona - Divano 2 posti
Armchair - 2-seater sofa 321

CELL128

Poltrona - Divano 2 posti
Armchair - 2-seater sofa 301

CELL SPACE

Poltrona - Divano 2 posti
Armchair - 2-seater sofa 309

CLASSIC

Direzionale - Manager - Meeting - Visitatore
Executive - Manager - Meeting - Visitor 145

DODO

Pouf
Pouf 347

DROP

Sistema componibile
Modular system 373

FIL

Tavolo
Table 393

GREEN'S

4 gambe
4-legs 289

ICE

Direzionale - Manager - Meeting - Visitatore
Executive - Manager - Meeting - Visitor 157

INVICTA

Operativa
Task 197

JOIN

Operativa
Task 237

JOY

Pouf
Pouf 343

LEAF

Operativa
Task 173

LIDO

Sistema componibile
Modular system 363

LINE

Direzionale - Manager - Meeting - Sgabello
Executive - Manager - Meeting - Stool 151

LOTUS

Meeting
Meeting 249

MAIL

Visitatore
Visitor 281

MESH LINE

Operativa
Task 207

MIKADO
4 gambe
4-legs



285

MILOS ELLE
Visitatore - 4 gambe - Sgabello
Visitor - 4-legs - Stool



261

MILOS LIFE
Meeting - Sgabello
Meeting - Stool



253

MILOS LOUNGE
Poltrona
Armchair



335

MILOS SHELL
Poltrona
Armchair

275

MILOS TAILOR
4 gambe - Sgabello
4-legs - Stool



269

NO NAME
Direzionale - Operativa
Executive - Task



211

NOVA
Direzionale - Operativa
Executive - Task

191

OF COURSE
Direzionale - Manager - Meeting - Visitatore
Executive - Manager - Meeting - Visitor



131

PASSE-PARTOUT
Meeting - Visitatore
Meeting - Visitor



219

PK
Meeting - Visitatore
Meeting - Visitor



225

REST
Tavolo
Table



389

SIT IT
Direzionale - Manager - Meeting
Executive - Manager - Meeting



125

SKATE
Operativa
Task



167

SOFFIO
Operativa
Task



201

SOUL
Meeting
Meeting



243

SPIRIT
Direzionale - Manager
Executive - Manager



161

TAB
Tavolo
Table



405

TEAM STRIKE
Direzionale - Operativa
Executive - Task



185

TEAM STRIKE EVO
Direzionale - Operativa
Executive - Task



179

TEAM W
Operativa
Task



215

TOBI
Poltrona - Divano 2 posti - Divano 3 posti
Armchair - 2-seater sofa - 3-seater sofa

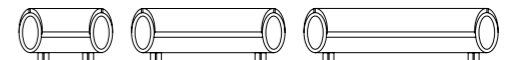

325

TOV
Tavolo
Table



397

UNI
Visitatore
Visitor



229



UNIMESH

Visitatore

Visitor



233

USE ME

Tavolo

Table



383

VEGA

Direzionale - Manager - Meeting - Visitatore

Executive - Manager - Meeting - Visitor



119

WHY NOT

Direzionale - Manager - Meeting

Executive - Manager - Meeting



137



CREDITS

Art direction, concept and graphics

Lucchesedesign

Scenes - set design

Lucchesedesign

Images

In-edito Studio

Paolo Leoni

We Do Spaces S.r.l. si riserva di apportare modifiche e/o migliorie di carattere tecnico ed estetico ai propri modelli e prodotti in qualsiasi momento e senza preavviso.

Le foto e i colori visualizzati sono puramente indicativi e possono variare rispetto alla realtà.

Per maggiori informazioni si prega di contattare il nostro Servizio Clienti presso service.italia@wedospaces.it

Proprietà intellettuale

Le collezioni presentate in questo catalogo sono protette da registri di progettazione industriale, brevetti di design, diritti d'autore e diritti di proprietà intellettuale a livello mondiale.

Tutti i disegni sono originali e di proprietà di We Do Spaces S.r.l., solo persone o società autorizzate da We Do Spaces S.r.l. hanno il diritto di utilizzarli. We Do Spaces S.r.l. eserciterà tutte le azioni legali eventualmente necessarie nei confronti di chiunque produca, commercializzi, utilizzi, venda, acquisti, importi o esporti i prodotti Sitland senza l'esplicita autorizzazione scritta dell'azienda con l'obiettivo di difendere la qualità, proteggere l'originalità e sottolineare il valore di ciascuno di questi progetti, We Do Spaces S.r.l., nell'interesse dei propri clienti, fornitori, dipendenti, progettisti e soggetti interessati. Per acquistare prodotti con il marchio Sitland o vi invitiamo a contattarci al numero +39 0444 637100 oppure inviare una e-mail a service.italia@wedospaces.it

We Do Spaces S.r.l. reserves the right to make modifications and improvements of a technical or aesthetic nature to the products at any time without notice.

Photos and colours shown are used for reference only and may look different in reality. For any further information, please contact our Customer Service at service.italia@wedospaces.it

Intellectual Property

The collections presented in this catalogue are protected by industrial design registers, design patents, copyright and intellectual property rights worldwide.

All designs are original, and are the property of We Do Spaces S.r.l.; only persons or companies authorized by We Do Spaces S.r.l. have permission to use them. We Do Spaces S.r.l. will take any and all necessary legal action against anyone who produces, markets, uses, sells, purchases, imports or exports Sitland products without the company's explicit written authorization, in order to defend the quality, protect the originality and emphasise the value of each of these We Do Spaces S.r.l. designs, in the interest of its clients, suppliers, employees, designers and other interested parties. To purchase Sitland brand products, please contact us by telephone on +39 0444 637100, or by e-mail at service.italia@wedospaces.it

We Do Spaces srl

Via XX Settembre, 272
33080 Roveredo in Piano
Pordenone / Italy

Secondary Operational Headquarters

Via Ca' Silvestre, 52
36024 Nanto (VI)
+39 0444 637100

Subject to the direction and coordination of We.Do Holding S.p.A.

